

Portable
FOLD-A-TANK[®]

ONE SUPERIOR SOURCE

■ FOR ALL YOUR PORTABLE WATER SYSTEM NEEDS ■



■ **THE ORIGINAL**
FOLDING FRAME PORTABLE
WATER TANK

SAFETY ■ DURABILITY ■ QUALITY

Family-owned
since 1954

THE FIRST AND STILL THE BEST... PORTABLE FOLDING FRAME TANK

THE FOL-DA-TANK® ADVANTAGE

The time-tested portable folding frame tank

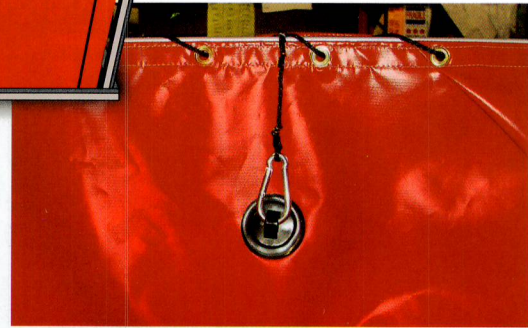
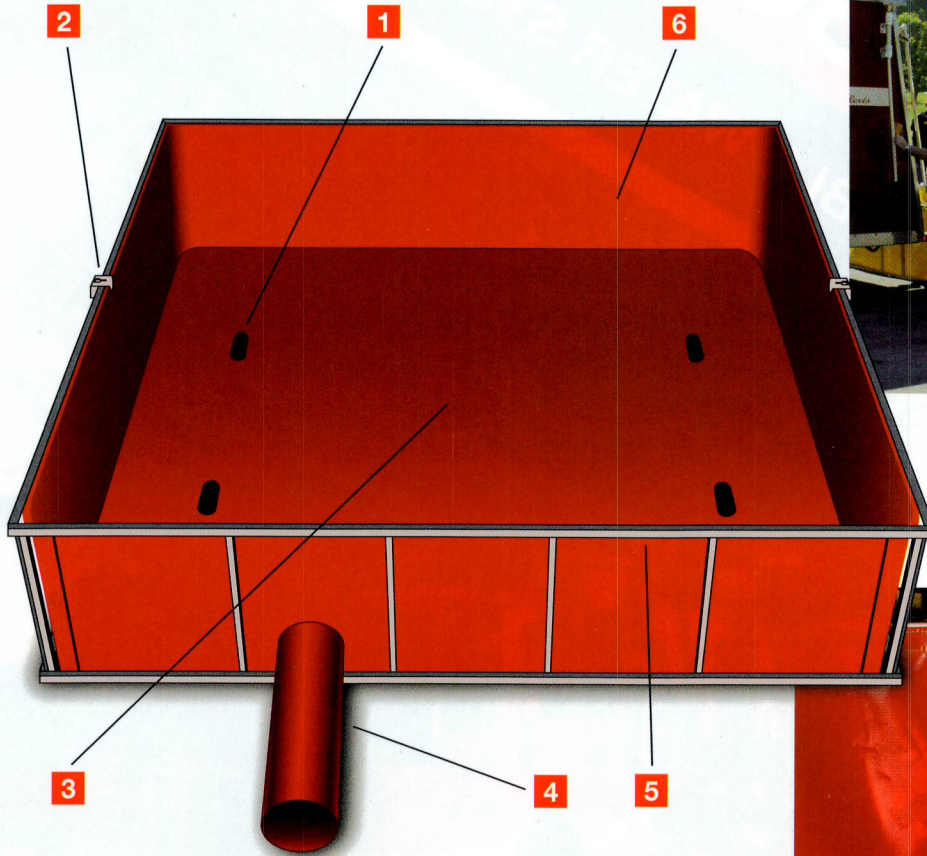

- 1 "Easy Lift Handles"** – Helps the firefighter to pick up and fold the liner when closing the tank. No zigzag pattern to interfere when using low-level strainers and power jet siphons. "Easy Lift Handles" can also be placed on the side walls for easy use. Grab handle kits are also available for existing tanks.
- 2 Hinge Protectors** – The patented "pinch free" design prevents the firefighter from pinching their hands when opening and closing the folding frames. No loss of frame strength with this design. US Patent #7,938,291 & Canadian Patent #2,624,553
- 3 Heavy Duty Floor Design** – When ordering a 22 oz. vinyl or HPR tank you can get an optional 30 oz. floor. There is no extra charge for this option. Just specify on your order.

- 4 Quick Release Drains** – See above photo
- 5 Frames Available** – See Page 3
- 6 Liner Fabric Available** – Fol-Da-Tank fabrics have been field tested and used in the most arid climates of the Middle East and cold climates of Alaska. (See Page 3)
- 7 NFPA Compliant** – p. 1142-33 c.14 Portable Drop Tanks
- 8 Lifetime Warranty** – Fol-Da-Tank Company products meet generally recognized standards of quality and excellence in the trade for goods of their type and kind. Should the heat sealed seams on a portable tank liner or the welds on a frame become defective Fol-Da-Tank Company offers a Lifetime Warranty replacement upon return for inspection.

PORTABLE FOLDING FRAME TANK

FRAME TYPES

Diagrams not to scale.

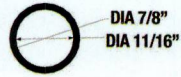

**7/8" OD 14GA
STEEL TUBING
(STANDARD STEEL FRAME)**

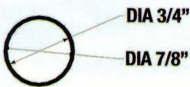

**7/8" OD 18GA
STEEL TUBING
(DECON POOLS)**

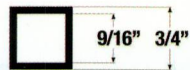

**3/4" SQUARE 14GA
STEEL TUBING**

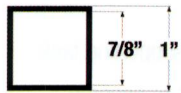

**1" SQUARE 16GA
STEEL TUBING**

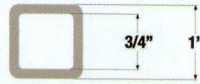

**1" SQUARE X 1/8" WALL
RADIUS CORNER
AIRCRAFT ALUMINUM
(STANDARD ALUMINUM FRAME)**

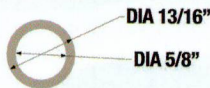

**1/2" SCHEDULE 40
ALUMINUM PIPE
(DECON POOLS)**

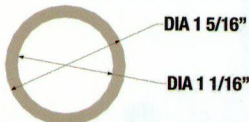

**1" SCHEDULE 40
ALUMINUM PIPE**

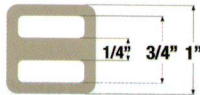

**H2™
1" SQ ALUMINUM**

LINER FABRICS AND COLORS

The most reliable fabrics to choose from.

- 17 oz. HPR® High Performance Rubber –Red or Yellow
- 22 oz. HPR® High Performance Rubber –Red or Yellow
- 22 oz. Vinyl –Red, Yellow, Blue, Orange Forest Green or Lime Green
- 30 oz. Vinyl –Red, Yellow, Orange or Black
- 23 oz. Urethane –Yellow



Colors shown are approximate.

Constructions Features:

- Solid brass grommets. Closely spaced to prevent the liner from sagging.
- Liner pick up grab handles (NEW & IMPROVED)
- Quick release drain sleeve.
- 22 oz. Vinyl or HPR® sides with heavy duty 32 oz. vinyl base liners available.
- Repair kits available for all liner fabrics.

FOLDING FRAME TANK SIZES AND DIMENSIONS

Size US Gallon/ Imp. Gallon/Liter	Open Feet/Meters	Steel Closed Feet/Meters	Alum. Closed Feet/Meters	Double-Fold Steel Closed Feet/Meters	Doulbe-Fold Alum. Closed Feet/Meters	Steel Weight	Alum. Weight
600/500/2200	6'3"x6'3"x29"/ 1.8x1.8x.71	6'3"x7"x29"/ 1.8x.18x.71	6'3"x8"x29"/ 1.8x.20x.71	3'x15"x29"/ .91x.38x.71	3'x16"x29"/ .91x.41x.71	95	70
1000/830/3800	8'3"x8'3"x29"/ 2.4x2.4x.71	8'3"x7"x29"/ 2.4x.18x.71	8'3"x8"x29"/ 2.4x.20x.71	4'3"x15"x29"/ 1.3x.38x.71	4'3"x16"x29"/ 1.3x.41x.71	125	95
1500/1250/5600	10'3"x10'3"x29"/ 3x3x.71	10'3"x7"x29"/ 3x.18x.71	10'3"x8"x29"/ 3x.20x.71	5'3"x15"x29"/ 1.6x.38x.71	5'3"x16"x29"/ 1.6x.41x.71	145	110
2100/1750/7500	11'3"x11'3"x29"/ 3.4x3.4x.71	11'3"x7"x29"/ 3.4x.18x.71	11'3"x8"x29"/ 3.4x.20x.71	5'9"x15"x29"/ 1.7x.38x.71	5'9"x16"x29"/ 1.7x.41x.71	165	125
2500*/2000/9500	12'3"x12'3"x29"/ 3.7x3.7x.71	12'3"x7"x29"/ 3.7x.18x.71	12'3"x8"x29"/ 3.7x.20x.71	6'3"x15"x29"/ 1.9x.38x.71	6'3"x16"x29"/ 1.9x.41x.71	175	130
3000*/2500/11300	13'3"x13'3"x29"/ 4x4x.71	13'3"x7"x29"/ 4x.18x.71	13'3"x8"x29"/ 4x.20x.71	6'9"x15"x29"/ 2.1x.38x.71	6'9"x16"x29"/ 2.1x.41x.71	185	135
3500*/2900/13250	14'3"x14'3"x29"/ 4.2x4.2x.71	14'3"x7"x29"/ 4.2x.18x.71	14'3"x8"x29"/ 4.2x.20x.71	7'3"x15"x29"/ 2.2x.38x.71	7'3"x16"x29"/ 2.2x.41x.71	210	155
4000*/3300/15000	15'3"x15'3"x29"/ 4.6x4.6x.71	15'3"x7"x29"/ 4.6x.18x.71	15'3"x8"x29"/ 4.6x.20x.71	7'9"x15"x29"/ 2.4x.38x.71	7'9"x16"x29"/ 2.4x.41x.71	250	185
5000*/4100/19000	17'x20"x24"/ 5.2x6.1x.61	10'x15"x24"/ 3.0x.38x.61	10'3"x16"x24"/ 3.0x.41x.61	10'3"x15"x24"/ 3.1x.38x.61	10'3"x16"x24"/ 3.1x.41x.61	300	220
5000*/4100/19000	17'x17"x29"/ 5.2x5.2x.71	17'x7"x29"/ 5.2x.18x.71	17'x8"x29"/ 5.2x.20x.71	8'9"x15"x29"/ 2.7x.38x.71	8'9"x16"x29"/ 2.7x.41x.71	300	220

All folding frame tanks come with patented pinch free design. *Come standard with 2 drain sleeves.

FIRE DEPARTMENT MODEL SELF-SUPPORTING TANK



Tank shown with use of hose stand.

The self-supporting frameless portable water tanks have been designed to meet the most stringent requirements of rural/urban fire fighting. Problems with inadequate or unusable supplies of water are eliminated by the use of open top self-supporting portable water tanks. In remote areas the self-supporting tanks are designed for standby water containment, water shuttling situations and provide a continuous portable water supply. In remote areas, the SST may be filled by pumping water from a natural water source, such as a stream or

creek, with a small gas operated pump. As the self-supporting tank begins to fill with water, its unique design allows it to become self-supporting automatically. The SST does not require any additional supporting framework, assembly, or frame installation. When no longer in use, the SST may be quickly drained through a fitting on the side. The SST is totally collapsible and easily stored in its own compact storage bag. It can be stored in the side or back of a truck, or the cargo compartment of a helicopter.

Features:

- Easy one-man setup
- Ethafoam collar – No need to inflate
- All self-supporting tanks are supplied with one threaded flange coupling installed. Sizes 1 ½" - 6", NST or NPSH, male or female. (Specify Choice)
- Any number and size of hose connections can be added for bottom drafting
- All seams welded for longer life. (See Warranty)
- Heavy duty vinyl (PVC)
- Easily repairable
- Storage bag included

Applications:

- Fire Fighting
- Water Relay
- Water Storage
- Mixing Tank (fire retardant)
- Hazardous Waste

Optional Accessories:

- Ground Covers
- Top Covers
- Patch Kits
- Hose Stand (see page 14)

Colors:

- Red
- Orange
- Black
- Yellow
- Blue
- Lime Green



Colors shown are approximate.

Aluminum Threaded Flanges:

Standard NST Threads – Male or Female

Options:

- NST
- NPSH
- STORZ
- CAM & GROOVE
- CANADIAN THREADS

Part No.**Size**

FLC-1.5	1 ½"/4cm
FLC-2.0	2"/5cm
FLC-2.5	2 ½"/6cm
FLC-3.0	3"/8cm
FLC-4.0	4"/10cm
FLC-4.5	4 ½"/11cm
FLC-5.0	5"/13cm
FLC-6.0	6"/15cm



6" NST female shown



Storage Bag



Hose Stand

Part No.	US Gal.	Imp. Gal.	Liters	Open Dimensions Feet/Meter	Folded Dimensions (Approx.) Inches/Centimeters	Weight Lbs./Kg.
SSTFD-500	500	420	1900	2'8"x5'x6'6"/.81x1.5x2	24"x17"/61x43	50/34
SSTFD-1000	1000	830	3800	2'8"x7'3"x8'10"/.81x2.2x2.7	26"x18"/66x46	60/27
SSTFD-1500	1500	1250	5600	2'8"x9'2"x11'10"/.81x2.8x3.6	26"x20"/66x51	70/31
SSTFD-2000	2000	1650	7500	2'8"x10'x12'5"/.81x3x3.8	26"x20"/66x51	75/34
SSTFD-2500	2500	2000	9500	2'8"x12'x13'6"/.81x3.7x4	34"x22"/86x56	95/43
SSTFD-3000	3000	2500	11300	2'8"x13'x14'9"/.81x4x4.5	34"x22"/86x56	105/48
SSTFD-4000	4000	3300	15000	2'8"x14'x18'/.81x4.3x4.9	36"x34"/91x61	110/50
SSTFD-5000	5000	4100	19000	2'8"x17'x19'/.81x5.2x5.08	38"x26"/97x66	130/59
SSTFD-6000	6000	5000	19000	2'8"x17'8"x21'2"/.864x5.4x6.45	40"x28"/101.6x71	130/59

FOREST SERVICE MODEL SELF-SUPPORTING TANK



Features:

- Special high sides
- Totally self-supporting
- Ethafoam collar - No need to inflate
- All self-supporting tanks are supplied with one threaded flange coupling installed. Sizes 1 1/2" – 6", NST or NPSH, male or female. (Specify Choice)
- Any number and size of hose connections can be added for bottom drafting
- All seams welded for longer life. (See Warranty)
- Heavy duty vinyl (PVC)
- Easily repairable
- Storage bag included
- Easy lift grab handles are placed evenly around the base of the tank for easy set up
- For 6,000 to 20,000 plus tanks we use all 35 oz or 40 oz. weight fabric

Applications:

- Fire Fighting
- Helicopter Dip Tank
- Water Relay
- Water Storage
- Mixing Tank

Optional Accessories:

- Ground Covers
- Top Covers
- Impact Pad
- Patch Kits

Aluminum Threaded Flanges:

Standard NST Threads – Male or Female

Options:

- NST
- NPSH
- STORZ
- CAM & GROOVE

Part No. Size

FLC-1.5	1 ½"/4cm
FLC-2.0	2"/5cm
FLC-2.5	2 ½"/6cm
FLC-3.0	3"/8cm
FLC-4.0	4"/10cm
FLC-4.5	4 ½"/11cm
FLC-5.0	5"/13cm
FLC-6.0	6"/15cm

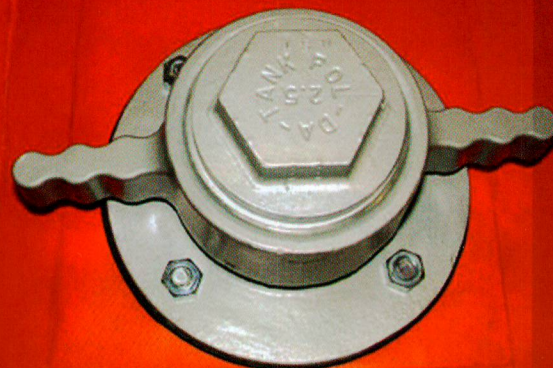

2.5" Threaded flange



Impact Pad



Storage Bag



Part No.	US Gal.	Imp. Gal.	Liters	Open Dimensions Feet/Meter	Folded Dimensions (Approx.) Inches/Centimeters	Weight Lbs./Kg.
SSTFD-500	500	420	1900	3'x5'x6'6"/1.9x1.5x2	24"x17"/61x43	50/23
SSTFD-1000	1000	830	3800	4'x7'x8'2"/1.2x2x2.5	26"x18"/66x46	60/27
SSTFD-1200	1200	1000	4500	4'x7'x8'10"/1.2x2x2.7	26"x20"/66x51	60/27
SSTFD-1600	1600	1300	6000	4'x7'x9'6"/1.2x2x2.9	26"x20"/66x51	75/34
SSTFD-1800	1800	1500	6800	4'x7'x9'10"/1.2x2x3	26"x20"/66x51	75/34
SSTFD-2000	2000	1650	7500	4'x7'5"x10'8"/1.2x2.3x3.2	26"x20"/66x51	75/34
SSTFD-2500	2500	2000	9500	4'x8'x12'6"/1.2x2.4x3.8	34"x22"/86x56	95/43
SSTFD-3000	3000	2500	11300	4'x9'10"x13'1"/1.2x3x4	34"x22"/86x56	105/48
SSTFD-4000	4000	3300	15000	4'x12'2"x16'10"/1.2x3.7x5	36"x34"/91x61	110/50
SSTFD-4800	4800	4000	18200	5'x11'x16'/1.5x5x3.3	38"x26"/97x66	110/50
SSTFD-5000	5000	4100	19000	4'x13'x17'6"/5.3x4x1.2	38"x26"/97x66	130/59
SSTFD-6000	6000	5000	22700	5'x12'x17'/1.5x3.7x5.3	40"x28"/101.6x71	130/59
SSTFD-10000	10000	8000	36320	6'8"x12'x19'8"/2x3.7x6	44"x36"/112x92	200/91
SSTFD-14000	14000	12000	54500	7'9"x12'x21'8"/2.4x3.7x6.6	48"x38"/121x97	250/113
SSTFD-20000	20000	16667	75700	8'x18'x24'/2.44x5.5x7.3	48"x48"x60"/121x121x152	400/181



Portable
FOLD-A-TANK

TM



FLYING WATER SERIES

MULTIFUNCTIONAL HELICOPTER TANK

Applications:

- Filling Back Pack Tanks
- Potable Water
- Foam Retardants
- Extinguishing Duff Embers
- Small/Light Pumps
- Gravity Feed Reservoirs
- Potable Water Fabric is Available

Constructions Features:

- Pyramid Shape Blivets
- Heavy Duty (PVC) Vinyl
- Transportable by Helicopter or Truck
- Heavy duty harness
- Kevlar thread
- Sling harness webbing (134F)

Part No.	72F	134F
US Gal.	72	134
Imp. Gal.	60	110
Liters	270	510
Filled Dimensions In./Cm.	45"x39"/114x100	53"x43"/135x110
Folded Dimensions In./Cm.	21"x20"x8"/53x51x20	19"x26"x4.5"/48x66x12
Discharge	1" hose w/3/4" Spigot	1" hose w/3/4" Spigot
Filler	4" Diameter	4" Diameter
Weight Lbs./Kg.	12/5	14/8

Part No.	FLY200	FLY300
US Gal.	240	360
Imp. Gal.	200	300
Liters	900	1360
Filled Dimensions In./Cm.	27"x29"x8"/68x74x20	30"x32"x12"/76x81x28
Discharge	1 1/2" Ball Valve	1 1/2" Ball Valve
Filler	4" Diameter	4" Diameter
Weight Lbs./Kg.	25/12	35/16
Filled Weight Lbs./Kg.	2030/919	3100/1400

COLLAPSIBLE PILLOW-STYLE BLADDER TANKS

Gray Water



- Firefighting –In remote areas
- Brush Firefighting
- Construction sites
- Decon waste storage
- Pressure washing
- Gray water shower storage
- Parks and nurseries
- Frac tank operations

Potable Water



- Drinking water
- Clean shower water for firefighters
- Rainwater harvesting
- Livestock troughs
- Temporary water stations in 3rd world countries
- Emergency drinking water placed in crawl spaces under cabins

Features:

- Potable water fabric NSF/ANSI 61 standard
- Eleven standard sizes
- Compact – easy to store
- Resists chemical contamination, mildew, rot and solar heat
- RF welded seams for longer life
- Severe weather tolerance to -40° Fahrenheit
- Fills and empties in minutes by pump or gravity flow
- Easily handled by one man
- 1 1/2"/4cm ball valve with female threads
- Large 4"/10cm dia. fill opening
- Transportable by truck
- XR-5 & Urethane fabric also available

*These tanks are NOT designed for handling petroleum products.

Part No. Gray Water	Part No. Potable	Part No. Chemical Restraint	Size US Gal./Imp. Gal./Liters	Filled Dimensions Inches/Meters	Weight Lbs./Kg.
GW-25	PW-25	CR-25	25/21/95	24"x36"x8"/.61x.91x.20	10/4.5
GW-50	PW-50	CR-50	50/42/189	36"x52"x9"/.91x1.3x.23	14/6.4
GW-75	PW-75	CR-75	75/62/284	42"x54"x9"/1.1x1.4x.23	16/7.3
GW-100	PW-100	CR-100	100/83/379	4'6"x4'10"x16"/1.4x1.5x.41	18/8.6
GW-150	PW-150	CR-150	150/125/568	60"x60"x12"/1.5x1.5x.30	20/9.1
GW-250	PW-250	CR-250	250/208/946	60"x84"x14"/1.5x2.1x.35	23/10.4
GW-275	PW-275	CR-275	275/230/1000	6'6"x6"x16"/2x1.8x.41	25/11.3
GW-300	PW-300	CR-300	300/250/1136	66"x84"x14"/1.7x2.1x.35	30/13.6
GW-525	PW-525	CR-525	525/400/1900	8'3"x5'4"x18"/2.5x1.7x.46	33/15
GW-800	PW-800	CR-800	800/660/3000	10'x6'x2'/3x1.8x.60	42/19
GW-1140	PW-1140	CR-1140	1140/950/4300	12'x7'x2'/3.7x2x.60	58/26
GW-1250	PW-1250	CR-1250	1250/1040/4732	114"x14'8"x18"/2.9x3.8x.46	60/27
GW-1340	PW-1340	CR-1340	1340/1100/5000	14'x7'x2'/4.3x2x.60	64/29
GW-1500	PW-1500	CR-1500	1500/1249/5670	14'11"x9'5"x2'/4.6x2.9x.60	67/31
GW-2000	PW-2000	CR-2000	2000/1650/7500	10'5"x12'x2'/3.2x3.7x.60	82/37
GW-2500	PW-2500	CR-2500	2500/2080/9460	12'7"x14'x2'/3.9x4.3x.60	90/44
GW-3000	PW-3000	CR-3000	3000/2500/11300	11'10"x14'x2'6"/3.6x4.3x.70	104/47
GW-4000	PW-4000	CR-4000	4000/3330/15140	18'x14'x3'/5.5x4.3x.90	120/55
GW-5000	PW-5000	CR-5000	5000/4100/19000	14'7"x18'10"x3'/5.5x4.3x.90	142/64

MINI-DAM®

For use along with forestry pumps and other hazardous containment. Required by USFS with use of pumps and gas cans.

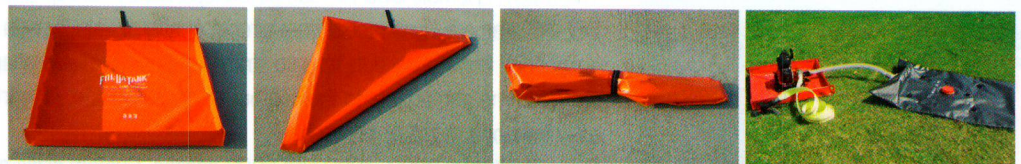

- Sizes: 3'x3'x4", 4'x4'x4", 5'x5'x4", and 5'x10'x5"
- Fabrics available: 18 oz. and 22 oz. Vinyl, HPR™ (High Performance Rubber) and XR-5

QUICK ASSEMBLE SERIES

ROL-LA-TANK®

ROL-LA-TANK® is the latest in relay storage tanks to provide temporary storage of liquids in remote areas. The light weight tank can be easily assembled by one person. Just unroll the tank, insert the support corners and hook the liner to the top snap clips. ROL-LA-TANK® has the advantages of a framed tank with the mobility of a self-supporting tank. The interior or exterior frame design can conform to uneven ground to prevent rolling. The liner is constructed from industrial strength vinyl with aluminum flanges available from 1.5" - 3.0" with male or female threads. Optional forestry quick connects and PVC flanges are also available. Comes with heavy duty storage bag. The ROL-LA-TANK® is also a great resource for oil spill containment and oil spill clean up.

Standard liner fabric is 22 oz. PVC available in red, yellow, orange, blue, green or black. Optional liner fabrics are 30 oz. PVC, chemical resistant and urethane.

Part No.	Stored Dimensions	Filled Dimensions	Top Opening	Weight
RLT-250	34"x14"x14"	4'4"x4'4"x35"	3'x3'	35 Lbs.
RLT-500	48"x17"x17"	6'x6'x35"	4'x4'	40 Lbs.
RLT-1000	48"x17"x17"	8'x8'x35"	5'9"x5'9"	60 Lbs.
RLT-1500	48"x17"x17"	9'x9'x35"	7'5"x7'5"	66 Lbs.
RLT-2000	48"x17"x17"	12'x12'x35"	8'x8'	90 Lbs.
RLT-2500	48"x17"x17"	13'7"x13'7"x35"	12'x12'	115 Lbs.
RLT-3000	48"x17"x17"	15'x15'x35"	12'9"x12'9"	118 Lbs.

ROL-LA-TANK® TYPE II

The ROL-LA-TANK® TYPE II is a quick assemble relay storage tank which provides temporary storage of liquids in remote areas. This lightweight tank can be easily assembled by one person using the snap-button connections. The ROL-LA-TANK® TYPE II is constructed from aircraft quality aluminum with interchangeable supports. The liner is constructed from industrial strength vinyl with aluminum or PVC flanges available from 1.5" - 3.0" male or female threads. The frame and liner are stored in a heavy duty storage bag with 2" seat belt webbing carry handles. The ROL-LA-TANK® TYPE II is also a great resource for oil spill containment and oil spill clean up.

Standard liner fabric is 22 oz. PVC available in red, yellow, orange, blue, green or black. Optional liner fabrics are 30 oz. PVC, chemical resistant and urethane

Part No.	Diameter x Height	No. of Legs/Rails	Weight
RLT II 500	6'x3'	6/6	55 Lbs.
RLT II 1000	8'x3'	6/6	75 Lbs.
RLT II 1500	10'x3'	6/6	77 Lbs.
RLT II 2000	11'6"x3'	8/8	90 Lbs.
RLT II 2500	12'6"x3'	8/8	95 Lbs.
RLT II 3000	13'8"x3'	8/8	110 Lbs.

QUICK ASSEMBLE DBL-HI®

The Quick Assemble DBL-HI® can be transported by helicopter or truck into remote areas for easy set up. The DBL-HI® frame is constructed from aircraft quality aluminum with al-mag snap button connections. The liner is suspended from heavy duty tension straps with quick release snap clips. The liner design relieves the pressure on the frame and adapts to the contour of the setup site. All parts are stored in a convenient storage bag for easy transport. **(GSA Approved)**

Sizes available: 3000, 4000 and 5000 gallons. Custom sizes also available.

Liner fabrics: 30 oz. PVC, 35 oz. PVC or 23 oz. Urethane

Flange connections: 2" - 4" PVC or aluminum (Other flanges available)



1500 Gallon tank shown



3000 Gallon tank shown



3000 Gallon tank shown

Construction Features:

- Light weight
- No tools required
- Quick set up
- Compact storage
- Convenient to transport



ALUMINUM LOW-FLOW STRAINER LOW-LEVEL

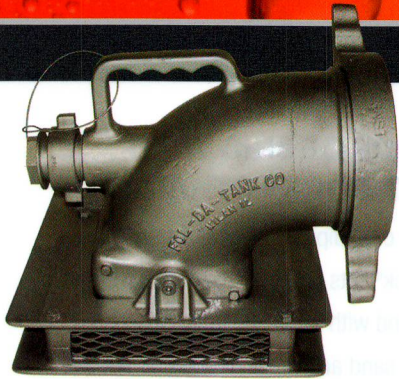

Construction Features:

- Professionally designed & engineered for maximum pumping capacity
- Al-Mag castings - proven to be the toughest in the industry
- The Low-Flow™ Low-Level will perform at maximum pumping capacity down to a water level of 1.5" - 2" depending on your set up area
- Flow Rate - Tested with 6" Low-Flow™ Low-Level rate is 1500 - 2000 GPM. The flow rates may vary due to the design of the pumper and the set up area of your pumper and Fol-Da-Tank
- Use of a male and female SST flange mounted on the side wall of your Fol-Da-Tank will eliminate the lifting factor when pumping from the side of the tank

- Long handle swivels with standard NH or NPSH threads
- Surface turbulence will not affect this strainer
- Optional 1.5" Water Transfer Device - available on sizes 4" to 6" (Must specify when ordering)
- Each unit is fully guaranteed
- The Low-Flow™ Low-Level is easily stored in truck compartments and can be pre-attached to hard suction hose (**NFPA 1142 Compliant**)

Part No.	Dimensions: In./Cm.	Weight
LFS 2.5	10"X10"X8 1/2"/25X25X22	7/3
LFS 3.0	10"X10"X8 1/2"/25X25X22	8/4
LFS 4.0	16"X13"X12"/41X33X31	23/11
LFS 4.5	16"X13"X12"/41X33X31	23/11
LFS 5.0	16"X13"X12"/41X33X31	24/11
LFS 6.0	16"X13"X12"/41X33X31	24/11



CLAPPER VALVE

This valve is specifically designed to maintain the prime between a pumper and a low level or floating strainer. When pumping through this valve GPM's will not be lowered. Made with 6061T6 aluminum tubing and Al-Mag castings. Clapper shown with use of 6.0" low level strainer. Sizes: 1.5" -6.0"



POWER JET SIPHON

The Power Jet Siphon is designed for use with two or more Fol-Da-Tanks. The siphon connects to a hard suction hose and assists the transfer of water from one tank to another. This keeps the main tank full of water for drafting as the secondary tank is refilled. The construction features include: durable al-mag alloy, aircraft quality tubing and 1 1/2" female assist by 4" - 6" discharge couplings. Standard threads are NST with other threads available. Storz and cam fittings are available upon request. (**NFPA 1142 compliant**)

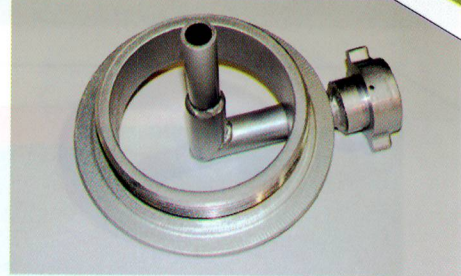

IN-LINE POWER JET SIPHON

The In-Line Power Jet Siphon is designed for use with two or more Fol-Da-Tanks. When the tanks are not close together, an In-Line Power Jet Siphon attached to two hard suction hoses assist water transfer from one tank to another. This keeps the main tank full of water for drafting as the secondary tank is refilled. In-Line Power Jet Siphons can also be used in ponds, creeks, or lakes to help transfer water to tankers and pumps. The In-Line Power Jet Siphon will also assist you with lift from a pond or creek that is lower than the level of the pumper truck. When using the In-Line Power Jet Siphon water or air can be used in the pumping process. Special attachments are available when using air. The construction features include: durable al-mag alloy, aircraft quality tubing and 1 1/2" female assist by 4" - 6" discharge couplings. Standard threads are NST with other threads available. Storz and cam fittings are available upon request. (**NFPA 1142 compliant**)

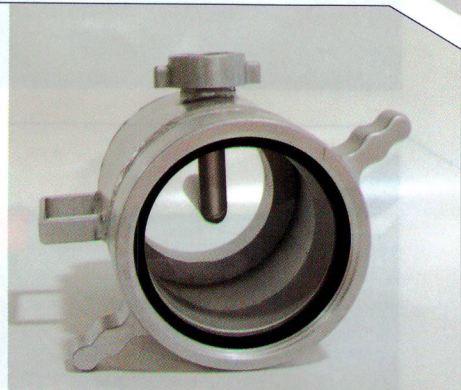

SELF-LEVELING FLOAT DOCK® STRAINER

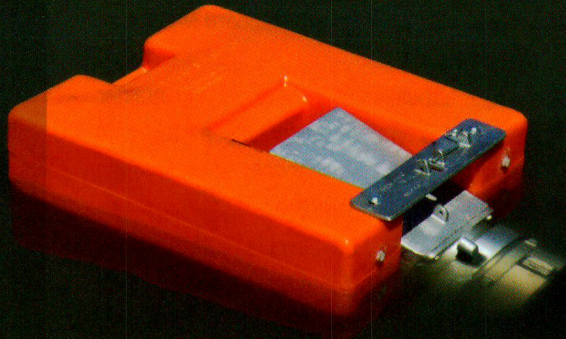

PUMP POND WATER FREE OF DEBRIS WITH THE SELF-LEVELING FLOAT DOCK® STRAINER

The Float Dock® strainer is a valuable piece of equipment that can save the day in many firefighting situations. Float Dock® lets you use the water in farm ponds or streams, both shallow and deep, and with a Fol-Da-Tank. Because it operates below scum and debris and above sand and muck, it screens out the materials that wear out impellers, packing and bearings. Since Float Dock® strainers are self-leveling, there are no whirlpools or suction loss. Each unit is fully guaranteed. (NFPA 1142 Compliant)

Construction Features:

- Professionally designed & engineered for maximum pumping capacity
- Polyethylene molded float with molded in carry handle (handle can be used for tie off and retrieval)
- No need for a vortex plate. The float prevents any whirl pooling
- Self-Leveling
- Al-Mag castings - Proven to be the toughest in the industry
- Long handle swivels with standard NH or NPSH threads
- 20-30% more open area at the intake
- Detach strainer and use separately as a "Box Strainer"
- All Float Dock® are available in all aluminum construction up to 8"
- Float Dock® drafts in as little as 5"/13 cm of water
- Optional riser will convert the strainer box into a low-level strainer
- 6" is recommended for pump rated at 1500 - 2000 GPM

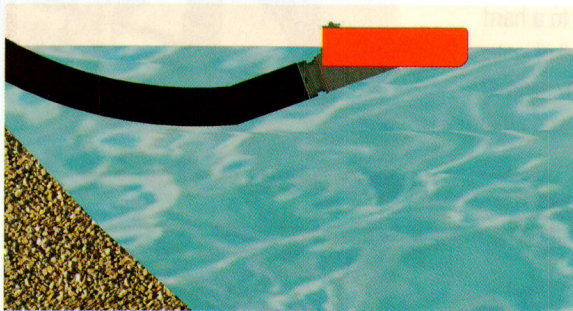

Deep Draft – Strainer drafts from a few inches below surface where water is cleanest. Note how hose weight tilts strainer position while float remains level. Right photo shown with riser.

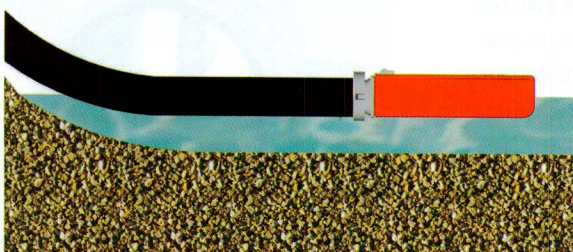
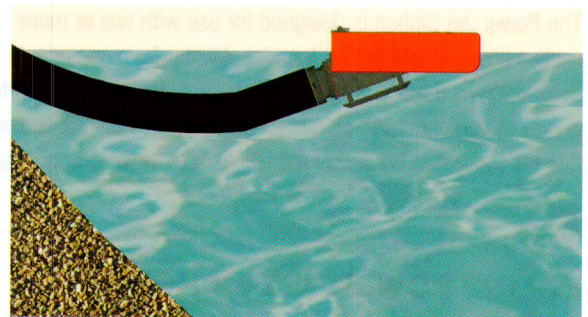

Shallow Draft – Note how Float Dock drafts in a little as 5"/13 cm depth without any whirl pool or loss of suction. Right photo shown with riser.

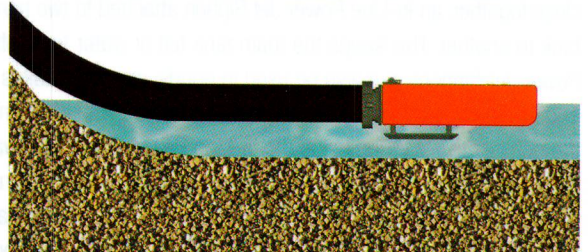

Part No.	Float Only Dimensions Inches/Centimeters	Strainer Only Dimensions Inches/Centimeters	Weight Lbs./Kg.
FDS 2.5	5"x15"x18"/13x38x47	4"x6"x14"/10x15x36	16/7
FDS 3.0	5"x15"x18"/13x38x47	4"x6"x14"/10x15x36	16/7
FDS 4.0	7"x21"x26"/18x53x67	7"x8"x15"/18x25x47	13/14
FDS 4.5	7"x21"x26"/18x53x67	7"x8"x15"/18x25x47	32/15
FDS 5.0	7"x21"x26"/18x53x67	7"x8"x15"/18x25x47	32/15
FDS 6.0	7"x21"x26"/18x53x67	7"x8"x15"/18x25x47	33/15

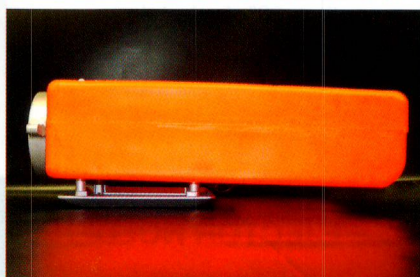
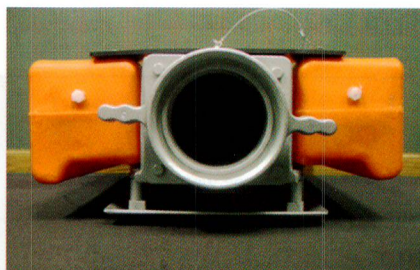

Three strainers in one with use of riser

- Floating strainer
- Low-level strainer
- Box strainer

Riser Part No. FDSR

Barrel Strainer with Foot Valve

- Valve body and poppet assembly are cast brass
- O-Ring is fitted to the poppet for a water tight seal
- Corrosion resistant materials for long lasting use
- Can be used in both vertical and horizontal positions
- Foot valve strainer can also be sold separately (Call)
- Sizes: 1.5" and 2.0" available

LEAD FREE - environmentally friendly



ACCESSORIES

SUPPLY LINE HOLDER

The Supply line holder couples hose securely to any portable water tank.

Construction Features:

- Added filling source
- Minimizes waste and turbulence
- Frees up manpower for other important duties
- Aluminum casting & Steel bracket
- NST and Storz available. Specify when ordering
- Pump tested to 200 PSI for single supply line holder
- Pump tested to 400 PSI for double supply line holder
- Round or square housing designs available for 4" & 5"
- Corner mounts available
- Convenient quick clamping with safety pins

NFPA 1142 Compliant

Part No.
S = Single
D = Double

SLHS 2.5

SLHD 2.5

SLHS 3.0

SLHD 3.0

SLHS 4.0

SLHS 5.0

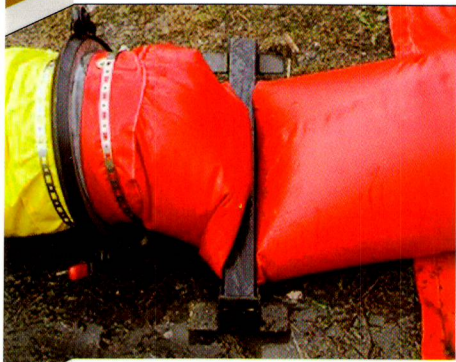

THE "CONNECTOR"™

The "Connector" equalizes water levels between two or more Fol-Da-Tanks. No priming necessary. Easily stored. Rugged aluminum castings. 10" standard size.

Part No. PTCS-10

BAR SLEEVE CLAMP

The Bar Sleeve Clamp controls water flow between tanks.

Part No. BSLC



SMOKE EJECTOR HOLDER

The Smoke Ejector Holder is made from 6061 aluminum tubing with heavy duty ratchet adjustment to exert maximum pressure for secure holding against any door jamb or window frame. The rubber grip pads tightly grip to smooth surfaces and easily adjusts from 28" - 40".

Part No. SEH

HOSE STAND

This light weight aluminum hose stand is designed to support a large diameter hose when filling and draining a Self-Supporting Tank or Rol-LaTank®. This hard suction hose support stores easily in limited spaces.

Part No. HSS

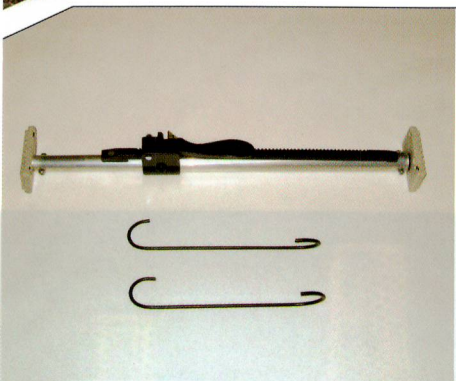

CARRY RACKS

Lightweight carrying rack can be mounted on a running board or inside a compartment. There are two sizes. Small is for 2.5", and 3" Float Dock® strainers and all Low-Flow strainers. Large is for 4", 4.5", 5", and 6" Float Dock® strainer.

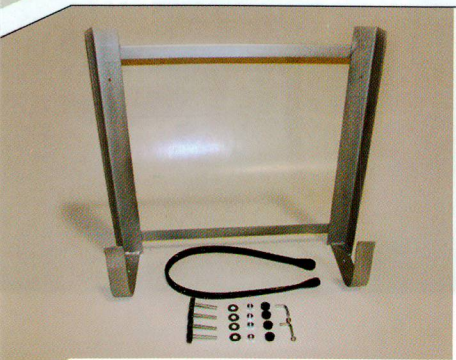

Part No. for Float Dock Strainer	Size	Part No. for Low Flow Strainer
FDSCR-SM	Small	LFSCR-SM
FDSCR-LG	Large	LFSCR-LG

COVERS & SPECIALTY TARPS

SALVAGE COVER

Strong, lightweight salvage covers are available in Canvas, Tuff 10-10 oz., 18 oz., 22 oz. Vinyl, 22 oz. HPR (High Performance Rubber™). Fabrics have been certified for over 30 years. (Meets NFPA 701 LS and California Fire Marshals standards)

Standard Sizes: 9x12, 12x14, 12x18 and 14x18.

Custom sizes available Hall runners available



GROUND COVER

Protects tank bottoms from excessive wear, abrasion, and punctures so tank life is increased and the tank stays cleaner. Heavy duty 22 oz. red or yellow HPR® High Performance Rubber, 22 oz. red, yellow or 30 oz. orange vinyl. Comes with 4 loop handles. All seams are heat sealed for longer life.

For framed tank sizes 600 - 5000 gallons

For self supporting tank sizes 250 - 20,000 gallons



DEBRIS CARRIER

Sizes: 6' x 8' & 8' x 8' Available in Canvas, 22 oz. Vinyl, and 22 oz. HPR® (High Performance Rubber) material.

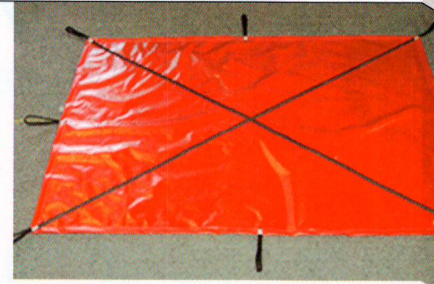

SOFT STRETCHER

The flexible stretcher measures 60 inches by 80 inches. The soft stretcher can be also used to move small children or adults in an emergency situation. Unlike fixed stretchers the soft stretcher can be easily maneuvered through stairwells, doorways and other confined spaces. Made with (10) heavy duty web handles and 30 oz. PVC material.

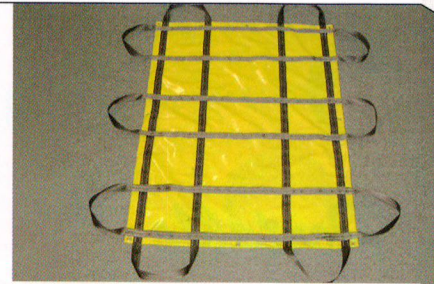

TRIAGE/TREATMENT AREA TARPS

Triage tarps are not disposable. They are constructed from vinyl coated nylon for many years of use. The tarps are reinforced at the corners with brass grommets to use as tie downs or suspension points. The 4 tarps (one each of red, blue, yellow and green) can be folded and stored in our convenient carry bag. Each tarp is 10' x 12'.



STAGING MAT

Features:

- Velcro panels form a 3' x 7' or 6' x 10' mat
- Comes standard with Green & Red panels marked FULL & EMPTY
- Color coded and labeled
- Ribbed storage area for air cylinders
- Carry case included



Portable
FOL-DA-TANK[®]



VISA

FOL-DA-TANK[®] COMPANY

P.O. Box 110

Milan, IL 61264

Phone: (309) 787-3500

(800) 637-8265

Fax: (309) 787-3635

E-Mail: info@fol-da-tank.com

www.fol-da-tank.com

WARRANTY POLICY: We warranty FOL-DA-TANK Co.[®] products to meet generally recognized standards of quality and excellence in the trade for goods of their type and kind. Should the heat sealed seams on a portable tank, replacement liner, self-supporting tank, tarp, berm or the welds on a frame become defective FOL-DA-TANK Co.[®] offers a LIFETIME WARRANTY replacement upon the return for inspection. All strainers and accessories are fully guaranteed. We reserve the right of requiring the return of defective parts or tanks, transportation and insurance be prepaid, before a claim is recognized. Upon customers proof of delivery our warranty will be in effect. Misuse or abuse will auto-matically void this warranty.

© 2012 FOL-DA-TANK Co.