







# «ABOUT US

For more than 20 years, Euramco Safety has served customers in the production of equipment used in some of the most dangerous environments on earth. You will find our equipment in potentially explosive atmospheres where flammable gases, vapors, mists, and dusts exist. Given a source of ignition, these substances can detonate and destroy life and property in seconds. Our fans can be found at the doorsteps of buildings on fire. Firefighters, using the latest ventilation techniques, deploy our fans to safely control the flow path and eject smoke from the buildings. You will find our products at confined spaces, which by design have limited openings for entry and exit with unfavorable natural ventilation which could contain or produce dangerous air contaminants.

We take the hazards of these situations seriously and make your safety a priority. We have established processes in manufacturing, quality management, logistics and after sales service to help ensure the safety and satisfaction of firefighters, roughnecks, military, construction workers and all others using our equipment in dangerous environments.

## MANUFACTURING

Euramco Safety's global headquarters is located in Spring Valley, CA, and operates manufacturing and distribution facilities in Contern, Luxembourg, Ningbo, China, and Dubai Logistics City, Dubai, UAE. Our company, rooted deeply in pump and turbine support services for the US Navy, was founded on principles of precision engineering, manufacturing expertise, and technical service competency.

Our engineering teams apply their collective experiences to ensure quality, performance and value is designed into every component on the bill of materials.

## QUALITY MANAGEMENT

The quality systems of this facility have been registered by UL to the ISO 9001 standards since 2004. With twelve consecutive audits successfully completed since, our team has evolved into a well-tuned machine where continuous product and process improvement, throughout all of our global locations, are embedded in our operational culture.



# Innovators in PPV

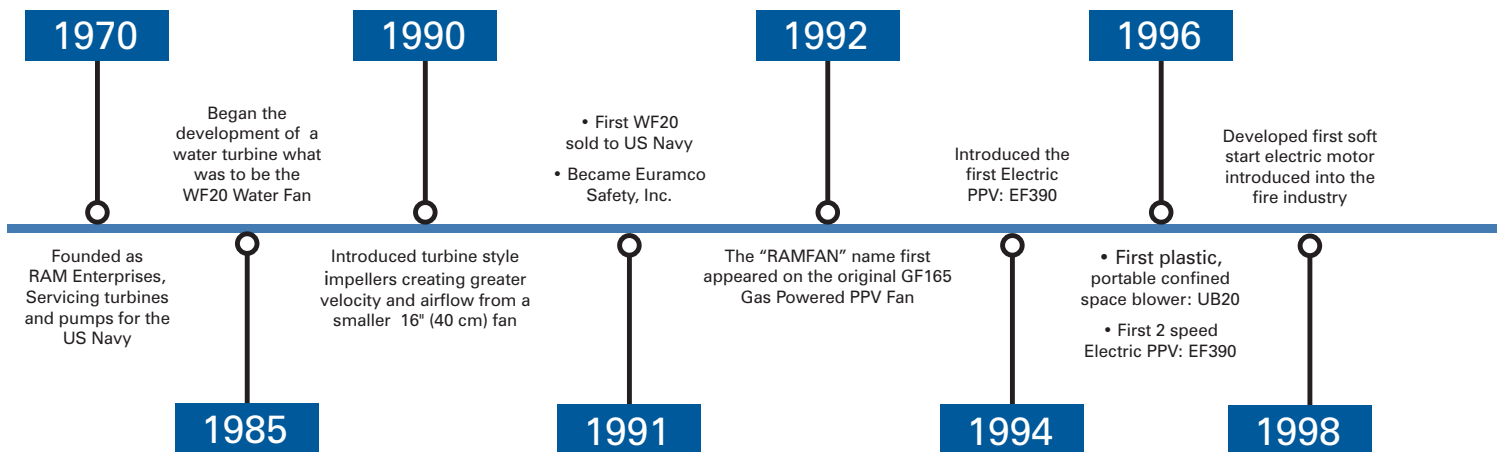

Our Quality Management Process covers the entire supply chain for all critical components, and is certified by DQS. This is a critical part of our commitment to our customers operating in hazardous locations, where our attention to precise detail is critical to the safety of their teams and their facility.

### LOGISTICS

We use proprietary algorithms automating internal product movement between production and distribution centers, optimizing inventory levels to nominal demand, by region.

We have regionalized customer service contact points to better serve our customers.

### AFTER-SALES SERVICE

We offer an extended warranty on products, not because we have to but because we believe in the quality of our products and stand behind them.

Field service engineers are available to help discuss how our products you purchased can be used. Competent sales engineers are ready to support via phone, email or live messaging. Whether you are a first time customer or still using our reliable fans sold over 20 years ago, we've always sought to provide the best service.

### TOGETHER WE'LL ACHIEVE MORE

Our strong foundation is built on your trust in us. We've rewarded your trust by continually introducing innovative technologies that focus on user safety while strengthening our core capabilities. You can count on us to always find a way to improve and advance the industries we are in. We look forward to working with you for years to come.

# Technology | Time Line

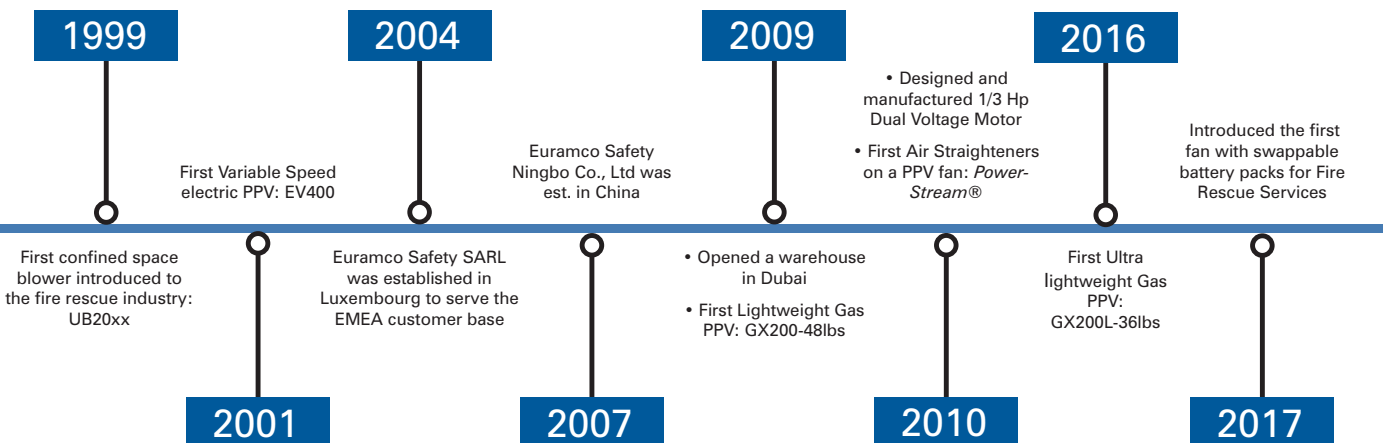

# «PRODUCT SELECTION GUIDE

## 1 Application



**Industrial Workplace**  
Environment with confined spaces



**Fire Rescue- Large Structure Ventilation**  
Large structures that need ventilation to remove smoke, heat and fire gases.



**Hazardous Workplace**  
Environment with a potentially explosive atmosphere



**Marine/Military**  
Shipboard de-smoking and equipment cooling



**Fire Rescue- Structural Ventilation**  
Small and mid-size buildings that need ventilation to remove smoke, heat and fire gases

## 2 Energy Source

### Gas

*Best Performance  
Best Portability*

### Electric

*Quick Operation  
Clean Atmosphere*

### Battery

*Quick Operation  
Clean Atmosphere  
Portable*

### Water

*Intrinsically Safe  
Clean Atmosphere*

### Compressed Air

*Intrinsically Safe*

## 3 Airflow Requirements

### DUCTED AIRFLOW

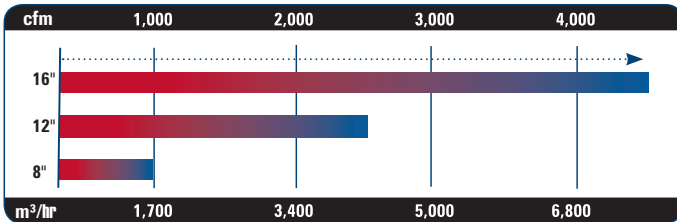

### PPV AIRFLOW

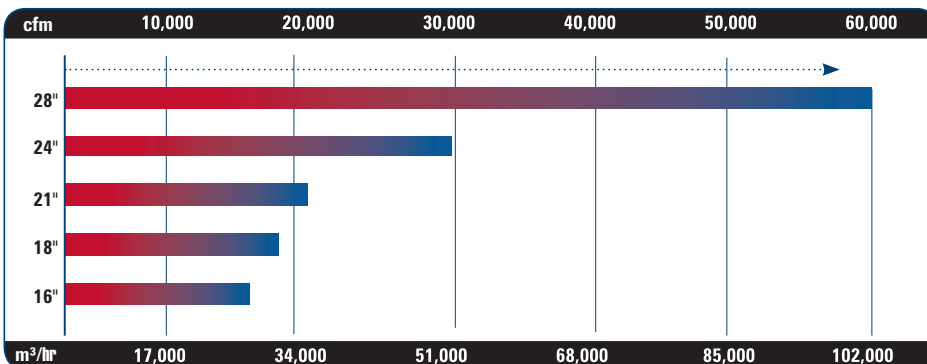

# «CONTENTS



8



## Industrial Workplace

Electric | Battery



16



## Hazardous Workplace

Electric | Compressed Air



28



## Fire Rescue

Gas | Electric | Battery | Water



44



## Marine/Military

Water



## EX50Li

### Revolutionary Battery Operated Fire Fighting Fan

Stay Unplugged, Indefinitely! Swappable battery packs with enhanced IP66 water jet protection to protect against the inevitable sweep of the fire hose. The ability to have extra packs ready to go removes the limitations of other battery fan concepts, leading towards full corded fan replacement on the fire ground.

40V Lithium-Ion Battery Packs! Advanced, High Energy Density 432 Wh Lithium Ion battery system was designed specifically for the high draw and sustained run-time applications demanded of PPV fans.

## IntelliSense™ E2 Controller

### Ramfan Next Generation Controller

Intellisense™ E2 is exclusively available in RAMFAN blowers. Euramco's latest generation of the Intellisense motor controller series, the E2 controller is tailor-made for firefighting and industrial operations. Its robust motor control algorithm is ideal for controlling motors in a broad range of industrial and firefighting, providing advanced capabilities and superior performance.

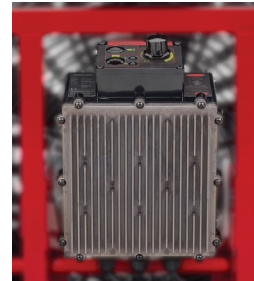

## 40V Battery Packs

### Remain Cordless & Keep Ventilating During Extended Ops

Advanced, High Energy Density 40V, 6Ah Lithium Ion battery packs are designed specifically for the high draw and sustained run-time applications demanded of RAMFAN blowers. Rapidly charge batteries in 4 hours with no memory loss effect after charging.

## Battery Charger

### Rapidly Charge Batteries

External battery charger that can be mounted in a fire apparatus or at the fire department to rapidly charge two RAMFAN 40V batteries at the same time in 4 hours.



## Vehicle Mount

### Custom Mounts For The Perfect Fit

Save space in your compartment by installing our custom vehicle mount that snugly wraps around the EX50Li and secures it in place.





## ***Integrated Shroud Platform***

### ***Night Ops***

400 Lumens of LED scene lights integrated into the shroud to illuminate the path in front of the blower. The energy efficient LEDs sip the power of the fan alleviating concern of dead batteries.

## ***GX200L***

### ***Ultra Lightweight PPV***

RAMFAN® GX200 Series set the bar again for the world's lightest PPV fan. The new "L" model, GX200L, designed for one-handed carry up staircases, weighs in at only 36 lbs (16 kg)! This is a full 12 lbs lighter than its bigger brother, with the full roll-cage, GX200. The new RAMFAN GX200L simplifies everything, while compromising nothing. Pre-tilted configuration allows you to simply set the fan back until the airstream is aimed where you want. Equipped with the Honda GXH50, this unit will address weight, airflow and CO emission targets for your department. 36 lbs (16 kg), 12,800 cfm (21,794 m<sup>3</sup>/hr) and CARB-certified with emissions so light it will barely register on CO meters due to its small displacement engine.



## ***2nd Generation Flow Straightening***

### ***Enhanced FlowPath™ Control***

The PowerStream® flow straighteners, standard equipment on EX and GX models, was the first flow straightening technology on PPV fans, increasing flow velocity and allowing more flexible setback positioning. Drawing on our nearly half century of experience in specialized rotational machinery, our engineering team has further refined the flow characteristics and efficiency of our PowerStream-equipped blowers by reducing boundary layer friction. We developed a secondary layer of flow, an outer friction-reducing layer, to more efficiently deliver the central mass volume flow needed to control the FlowPath™ deeper into the structure.

## ***New Duct Adapter/Reducer!***

### ***Multi-Mission Capability for EX/GX Models***

New Adapter/Reducer allows your 18" (46cm) GX/EX blowers to be used with standard ECKO Flex 16" duct. Mounting points integrated into the outer shroud do not interfere with airflow during normal PPV ops. During ducted ops, 100% of the airflow is captured to create a high-pressure flow, reducing friction loss through the length of the duct.



## ***Doorbar and Hanger Kit***

### ***New, Lightweight Design***

Best value available. Our new Doorbar and Hanger Kit is easier to use, install and carry. The new adjustable straps on the hangers allow you to position the fan with less lateral movement and greater range of height. Straps connect to the fan when not in use providing a handy carrying strap. The extended feet on the doorbar fit snug in the door jam for quick, easy set-up.

# «INDUSTRIAL WORKPLACE



## Applications

- Manholes
- Tanks
- Vats
- Silos
- Utility Vaults
- Tents/Shelters
- Factories
- Aircraft
- Rail Cars
- Tunnels
- Crawl Spaces
- Other

# «PICK THE CORRECT FAN

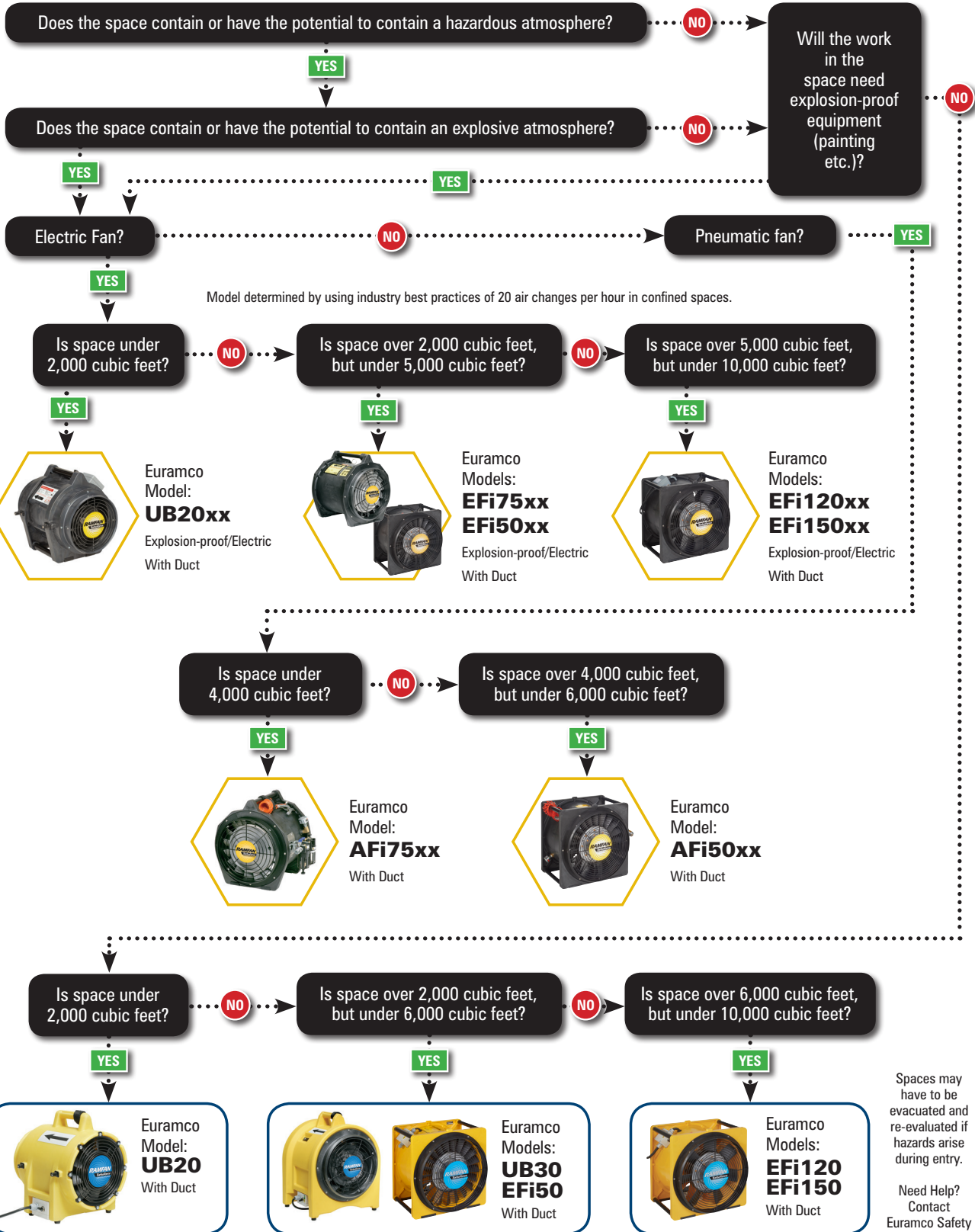

HAZARDOUS LOCATION

INDUSTRIAL/CONFINED SPACE

Spaces may have to be evacuated and re-evaluated if hazards arise during entry.

Need Help? Contact Euramco Safety

# «HOW TO ORDER

Voltage	Cable Lengths	Plug Types
<input type="checkbox"/> 115V	<input type="checkbox"/> Standard  Additional lengths available upon request	<input type="checkbox"/> 15A NEMA 5-15P <input type="checkbox"/> 20A NEMA 5-20P <input type="checkbox"/> 15A NEMA Twistlock L5-15P <input type="checkbox"/> 20A NEMA Twistlock L5-20P
<input type="checkbox"/> 230V	<input type="checkbox"/> Standard  Additional lengths available upon request	<input type="checkbox"/> 16A HD Schuko, Heavy Duty <input type="checkbox"/> 20A NEMA Twistlock-L6-20P <input type="checkbox"/> 15A NEMA 615-P
		<input type="checkbox"/> Pigtail Adapter 5-15P to L5-20R Additional Plugs available upon request. Please contact Customer Service with country of operations. Plug must meet voltage and amperage requirements of the fan.

## **Place Your Order**

**For prompt, accurate ordering please be able to provide the following:**

- A Purchase Order or letter with the company name or logo, address & approval signature. Purchase Orders must include a P.O. #, Bill To Address, Ship To Address (can't be a P.O. box), Model #, Order #, quantity of each products ordered and shipping method.
- A confirmation will follow all orders placed.

**Purchase Orders can be received by**  
**Fax: +1 (619) 670-7345 or Email: [theteam@euramcosafety.com](mailto:theteam@euramcosafety.com)**

# «PRODUCT SELECTION GUIDE

1

## Energy Source

### Electric

*Quick Operation  
Clean Atmosphere*

### Battery

*Quick Operation  
Clean Atmosphere  
Portable*

2

## Airflow Requirements

### DUCTED AIRFLOW

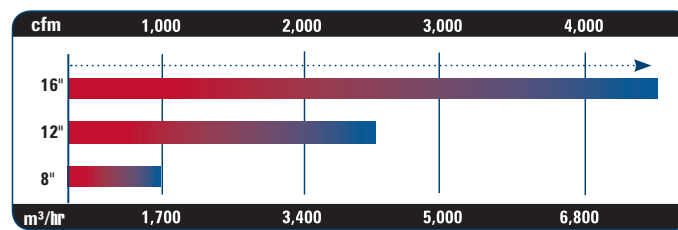

3

## Sizes Available

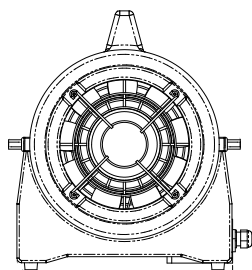

**8"/20 cm**

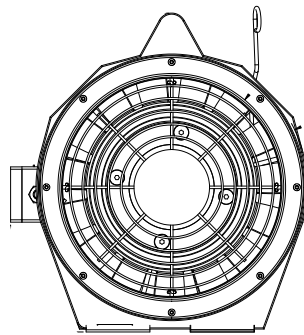

**12"/30 cm**

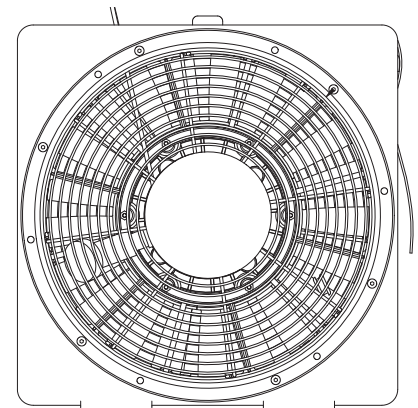

**16"/40 cm**

# «RAMFAN® ELECTRIC Blowers/Exhausters

RAMFAN® combines high performance, axial turbofan design with high strength polymers to create a line of rugged, portable turbo blowers. The UB-Line is ideal for general use, confined space ventilation and delivers the highest airflow in it's class. The light-weight, corrosion and chemical resistant, double-wall, polyethylene casing handles the bumps and falls of any job site. Equipped with an IP55 water resistant switch enclosure and a thermal switch to protect the motor from overheating.

Use the UB-Line of blowers to ventilate a permit-required confined spaces to comply with OSHA Standards 29 CFR 1910.146(c)(5)(ii)(E) stating, Continuous forced air ventilation shall be used. Confined Space refers to a space which by design has limited openings for entry and exit, unfavorable natural ventilation which could contain or produce dangerous air contaminants, and which is not intended for continuous employee occupancy.

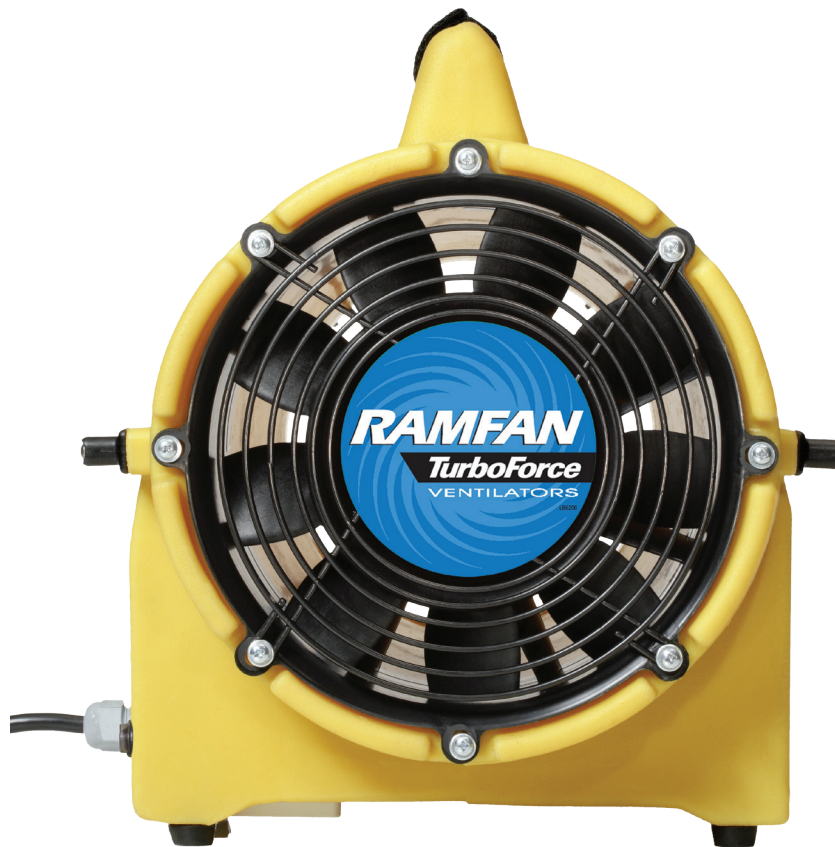

# Ventilation Systems & Kits

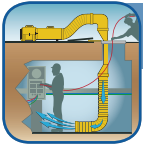

## UB20 M.E.D.™ Manhole Entry System AC/DC

The M.E.D.™ allows workers to enter and exit small man-size openings while maintaining continuous ventilation. Without such a device, duct fills the manhole opening, preventing rapid entry and exit.

*All Systems include: UB20, Quick-Couple Canister with 15'/4.6m duct and 5'/1.5m duct, Manhole Entry Device (MED), 90° elbow, universal mount and duct adapter*

Order No#	ED7015-MED UB20 (115V)	ED8015-MED UB20 (230V)	ED9015-MED UB20 (12V DC)
-----------	---------------------------	---------------------------	-----------------------------

See pg 15 for individual components



## Battery Pak System UB20 (12V DC) with Pak & Charger

RAMFAN Battery Pak with dual high-low speed control to quickly purge the area then maintain fresh air for the entire work shift. Power fan for 2.5 hours on high setting or extend up to 8 hours on low setting. Built in charger to fully recharge in 12 hours. Alternatively, the fan can be powered by a vehicle battery with supplied connectors.

*All systems include: UB20 (12V DC), Battery Pak with Built-in Charger, Battery Clips and Quick Couple Canister with duct. Charger voltage and duct length will vary by order#.*



Order No#	ED9015-BAT 115V Charger 15'/4.6 m duct	ED9015-BATCE 230V Charger 15'/4.6 m duct	ED9025-BAT 115V Charger 25'/7.6 m duct	ED9025-BATCE 230V Charger 25'/7.6 m duct	ED9002-BAT 115V Charger Canister & duct not included
-----------	--	--	--	--	--

See pg 15 for individual components

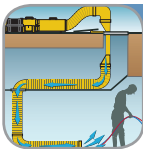

## Extended Duct System

Quickly connect two or more RAMFAN UB20 axial blowers in series increases airflow up to 50% when blowing through long and windy duct runs. Long, windy duct runs need more power and pressure to deliver sufficient airflow, a costly proposition. The Turbo-Couple™ delivers what is needed by quickly joining two or more UB20's in series.



Order No#	ED7000TC - 115V UB20 (qty. 2) and Turbo-Couple	ED8000TC - 230V UB20 (qty. 2) and Turbo-Couple
-----------	--	--

See pg 15 for individual components



## UB20 In-Line Heating System

Easily connect the UB20 In-Line Heater to heat confined spaces, command centers or rescue shelters for up to 8 hours. Delivers up to 55,000 BTU of safe, warm breathable air.

*The system includes: 115V UB20, Propane Heater and duct*

Order No#	ED7125-HT - Heater System w/ 15'/4.6 m duct and carry bag	HA01-100HT - Heater System w/ 15'/4.6 m duct and Quick-Couple™ canister	HA01-125HT - Heater System w/ 25'/7.6 m duct and Quick-Couple™ canister
-----------	---	--	--

See pg 15 for individual components

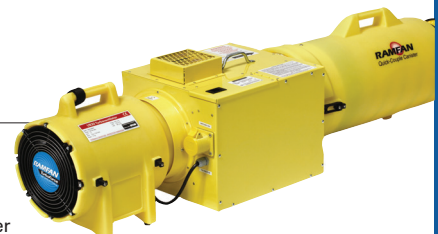

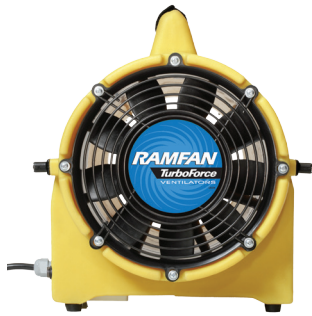

US Patent NO. D583,461; D585,972; D588, 537 (12V DC)

### UB20 Blower/Exhauster 8"/20 cm

The 8"/20 cm UB20 turbo blower is at the heart of the RAMFAN industrial ventilation systems that provide you with the complete solution for common confined space ventilation applications. The multi-purpose blower and exhauster delivers powerful airflow in a compact and lightweight package. Optional Quick-Couple Canister.

	UB20 (115V)	UB20 (230V)	UB20 (12V DC)
<b>Order No#</b>	ED7002	ED8002	ED9002
<b>Motor</b>	0.33 Hp (0.25 kW)	0.33 Hp (0.25 kW)	0.25 Hp (0.19 kW)
<b>Power</b>	115V, 1ø, 50/60Hz	230V, 1ø, 50/60Hz	12VDC
<b>Free Air</b>	980 cfm (1,666 m <sup>3</sup> /hr)	819 cfm (1,392 m <sup>3</sup> /hr)	862 cfm (1,465 m <sup>3</sup> /hr)
<b>Through Duct</b>			
15/4.6 m w/ one 90° turn:	789 cfm (1,341 m <sup>3</sup> /hr)	659 cfm (1,120 m <sup>3</sup> /hr)	695 cfm (1,181 m <sup>3</sup> /hr)
15/4.6 m w/ two 90° turns:	666 cfm (1,132 m <sup>3</sup> /hr)	558 cfm (948 m <sup>3</sup> /hr)	586 cfm (996 m <sup>3</sup> /hr)
25/7.6 m w/ one 90° turn:	722 cfm (1,227 m <sup>3</sup> /hr)	603 cfm (1,025 m <sup>3</sup> /hr)	
25/7.6 m w/ two 90° turns:	614 cfm (1,044 m <sup>3</sup> /hr)	510 cfm (867 m <sup>3</sup> /hr)	
<b>Weight</b>	17 lbs (8 kg)	17 lbs (8 kg)	17 lbs (8 kg)

### UB30 High Blower/Exhauster 12"/30 cm

The UB30 is durable, easy to maintain and versatile blower or exhauster with greater airflow than the UB20 for larger confined space applications. Its stackable design feature is convenient for storing multiple fans. Optional 8" (20 cm) duct reducer accessory to connect to smaller diameter duct. Compatible with UB20 M.E.D™ System.

	UB30 (115V)	UB30 (230V)
<b>Order No#</b>	EJ4002	EJ8002
<b>Motor</b>	1 Hp (0.75 kW)	1 Hp (0.75 kW)
<b>Power</b>	115V, 1ø, 50/60Hz	230V, 1ø, 50/60Hz
<b>Free Air</b>	2,420 cfm (4,114 m <sup>3</sup> /hr)	2,017 cfm (3,429 m <sup>3</sup> /hr)
<b>Through Duct</b>		
15/4.6 m w/ no turns:	2,250 cfm (3,485 m <sup>3</sup> /hr)	1,650 cfm (2,805 m <sup>3</sup> /hr)
15/4.6 m w/ one 90° turn:	2,050 cfm (3,485 m <sup>3</sup> /hr)	1,500 cfm (2,550 m <sup>3</sup> /hr)
15/4.6 m w/ two 90° turns:	1,875 cfm (3,188 m <sup>3</sup> /hr)	1,376 cfm (2,340 m <sup>3</sup> /hr)
25/7.6 m w/ one 90° turn:	1,825 cfm (3,103 m <sup>3</sup> /hr)	1,400 cfm (2,380 m <sup>3</sup> /hr)
25/7.6 m w/ two 90° turns:	1,750 cfm (2,975 m <sup>3</sup> /hr)	1,324 cfm (2,250 m <sup>3</sup> /hr)
<b>Weight</b>	37 lbs (17 kg)	37 lbs (17 kg)



### EFi50/EFi120/EFi150 High Blower/Exhauster 16"/40 cm

The largest portable, ducted blowers for highest volume air movement. Use the EFi50 (0.5 Hp) when you need a high volume, low velocity, somewhat gentler flow; or the EFi150 (1.5 Hp) model for higher velocities, increased volumes and reduced purge or cooling times. Durable EFi series fans have high strength, glass reinforced ABS housing. Stackable in storage or during operation.

	EFi50	EFi120	EFi150
<b>Order No#</b>	EA8000, EA8000-230	EA8120	EG8200, EG8200-230, EG8200CE
<b>Motor</b>	0.5 Hp (0.37 kW)	1.2 Hp (0.9 kW)	1.5 Hp (1.1 kW)
<b>Power</b>	115/230V, 1ø, 50/60Hz	230V, 1ø, 50Hz	115/230V, 1ø, 50/60Hz
<b>Free Air</b>	3,200 cfm (5,440 m <sup>3</sup> /hr)	3,750 cfm (6,375 m <sup>3</sup> /hr)	4,459 cfm (7,580 m <sup>3</sup> /hr)
<b>Through Duct</b>			
15/4.6 m w/ one 90° turn:	1,934 cfm (3,289 m <sup>3</sup> /hr)	2,700 cfm (4,590 m <sup>3</sup> /hr)	3,179 cfm (5,404 m <sup>3</sup> /hr)
<b>Weight</b>	46 lbs (21 kg)	53 lbs (24 kg)	55 lbs (25 kg)



## ACCESSORIES



### Quick-Couple™ Reversible Canister

Stores and protects attached duct from rips and tears. Quick and easy to attach or detach canister to UB20 to blow or exhaust air from an area. Available with 15' (4.6 m) or 25' (7.6 m) duct lengths.

Order# ED7015 - UB20 (115V) w/ Quick-Couple™ Canister and 15'/4.6 m duct  
 Order# ED7025 - UB20 (115V) w/ Quick-Couple™ Canister and 25'/7.6 m duct  
 Order# ED8015 - UB20 (230V) w/ Quick-Couple™ Canister and 15'/4.6 m duct  
 Order# ED8025 - UB20 (230V) w/ Quick-Couple™ Canister and 25'/7.6 m duct  
 Order# ED9015 - UB20 (12V DC) w/ Quick-Couple™ Canister and 15'/4.6 m duct  
 Order# ED9025 - UB20 (12V DC) w/ Quick-Couple™ Canister and 25'/4.6 m duct  
 Order# ED7004CS - Quick-Couple™ Canister w/ 15'/4.6 m duct  
 Order# ED7004CL - Quick-Couple™ Canister w/ 25'/7.6 m duct  
 Order# ED7004CL/DS - Quick-Couple™ Canister w/ (2pcs) 5'/1.5 m and 15'/4.6 m duct

### Components

#### MED System:

Order# MED5100 - M.E.D. Vent, 90° Elbow and Universal Mount (no blower)  
 Order# MED189 - M.E.D. Vent  
 Order# MED90 - 90° Elbow  
 Order# MEDUM - Universal Mount

#### Battery Pak System:

Order# BPV-12 - Battery Pak with built in charger (115V)  
 Order# BPV-12CE - Battery Pak with built in charger (230V)  
 Order# ED-SMH5 - Cord Connector (ED-BP612) plug to DC Blower (5ft cable and SMH plugs)  
 Order# ED-SMHBC15 - Barttery Pack (ED-BP612) Battery Clip Adapter

#### Extended Duct System:

Order# ED7300 - UB20 Turbo-Couple

#### Heating System:

Order# HA01 - 55k BTU Propane Heater with Thermostat and Regulator  
 Order# HA01T1 - Heater Thermostat control w/ 25'/7.6 m cable  
 Order# HAT25EXT - Heater Thermostat extension cable, 25'/7.6 m

#### Layflat Duct

Order# FDT-1625SME - 16"/40 cm Unreinforced Layflat duct, 25'/7.6 m  
 Order# FDT-L4X10SME - 16"/40 cm 90° Unreinforced Layflat duct, 4' x 10'

#### Disposable Duct

Order# FDT-12DISP - 12"/30 cm Disposable Layflat polyethylene duct sold by the foot  
 Order# FDT-16DISP - 16"/40 cm Disposable Layflat polyethylene duct sold by the foot

#### UB20 Inlet Duct Adapter:

Order# ED0304 - Inlet duct adapter

#### Duct Adapter/Reducer:

Order# EC0301 - 8"/20 cm duct adapter/reducer for 12"/30 cm fans

#### Duct Couplers

DC8 - 8"/20 cm duct coupler  
 DC12 - 12"/30 cm duct coupler  
 DC16 - 16"/40 cm duct coupler

### Standard Duct & Storage Bags

Non-Collapsible reinforced duct is flame retardant. Each duct comes with its own bag.

Order# FDT-21624046BR - 8"/20 cm diameter duct, 15'/4.6 m with storage bag  
 Order# FDT-21624076BR - 8"/20 cm diameter duct, 25'/7.6 m with storage bag  
 Order# FDT-30534005BB - 12"/30 cm diameter duct, 16'/5 m with storage bag  
 Order# FDT30534010BB - 12"/30 cm diameter duct, 32'/10 m with storage bag  
 Order# FDT-1615BR - 16"/40 cm diameter duct, 15'/4.6 m with storage bag  
 Order# FDT-1625BR - 16"/40 cm diameter duct, 25'/7.6 m with storage bag

### Replacement Duct for Quick-Couple™ Canister

Order# FDT-0805CB - 8"/20 cm x 5'/1.5 m  
 Order# FDT-0815CR - 8"/20 cm x 15'/4.6 m  
 Order# FDT-0825CR - 8"/20 cm x 25'/7.6 m

### Storage Bags

Order# BG8 - 8"/20 cm duct storage bag  
 Order# BG12 - 12"/30 cm duct storage bag  
 Order# BG16 - 16"/40 cm duct storage bag



# «HAZARDOUS WORKPLACE

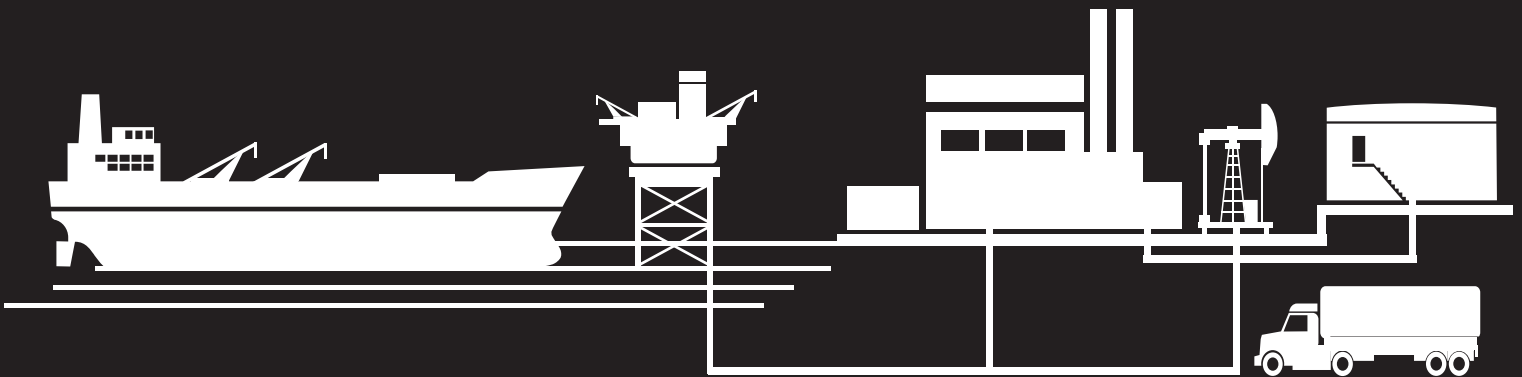

## Applications

- Shipbuilding and Repair
- Offshore Platforms
- Utilities
- Underground Work
- Chemical Plants
- Manholes
- Vessels and Tanks
- FPSO (Floating Production Storage and Off loading)
- Confined Spaces

# «PICK THE CORRECT FAN

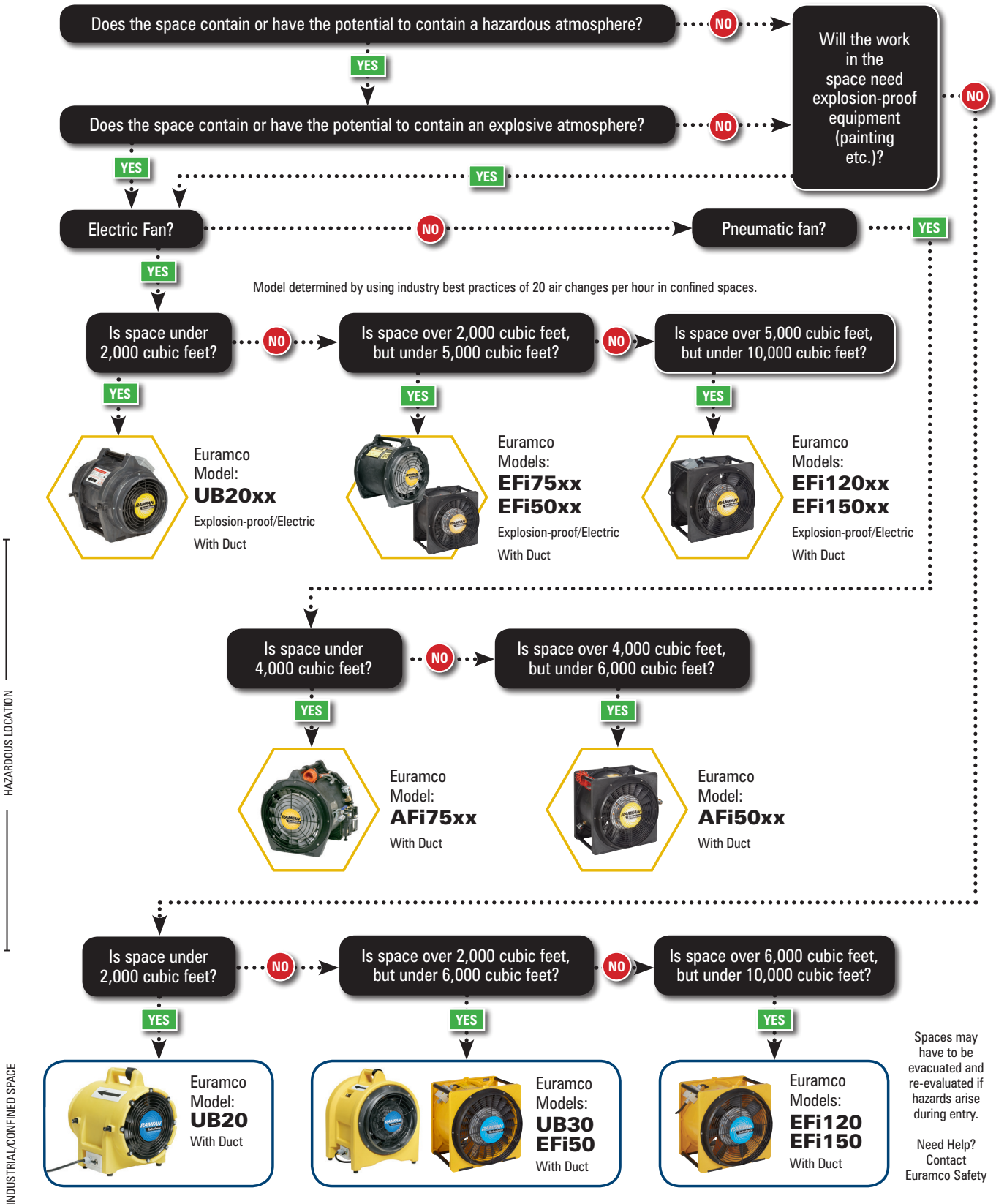

# «EQUIPMENT CERTIFICATIONS

## ATEX EXPLAINED

### Worldwide Certified Explosion-Proof Ventilators

Euramco Safety has designed and manufactured a line of fans specifically for use in hazardous atmospheres to meet the standards specified by the ATEX Directive 94/9/EC, IECEx, CE, INMETRO and UL. Our certifications cover the whole unit: the motor, terminal box, power cable, fan blade and labeling.

These Standards apply to all electrical equipment to prevent or minimize potential source of ignition in hazardous gas, dust or vapor atmospheres, to the extent defined in the charts below.

The chart explains the ATEX Identification Numbering System. The highlighted areas specifically apply to the ATEX string seen on Euramco Safety's certified hazardous location fans.

### Certifications:

IECEX UL Certificate #: **13.0062X**  
 EC-Type Examination Certificate #: **DEMKO 09 ATEX 0926969X**  
 INMETRO Certificate #: **UL-BR 13.0593X**  
 CE Hazardous Location Marking: **CE0539**  
 Ingress Protection: **IP55**



Equipment Group	Equipment Category	Protection Level	Hazard Gas	Dust	Use
II - Industrial (non-Mining)	1	Very high protection	G	-	Zones 0, 1, 2
	2	High protection	G	-	Zones 20, 21, 22

Area Classification	Zone Criteria (based on frequency and duration)
Zone 0	Potentially Explosive substance present continuously or for long periods >1000hrs/yr
Zone 1	Potentially Explosive substance likely to be present in normal operation >10hrs <1000hrs/yr
Zone 2	Potentially Explosive substance unlikely to be present in normal operation, if it does will only be for short periods <10hrs/yr

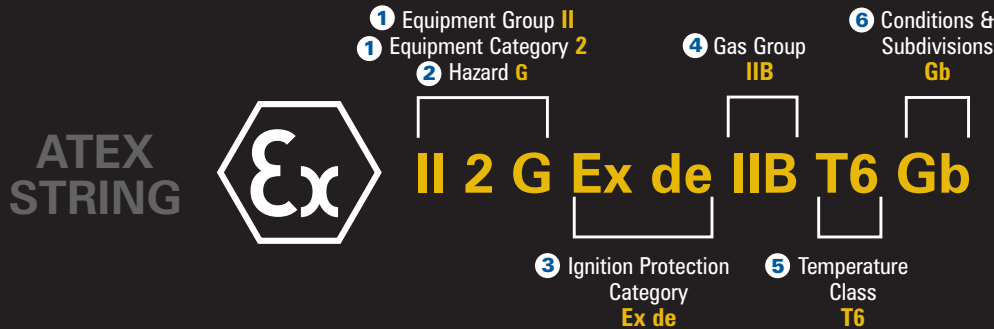

Gas Group	Representative Test Gas
IIA	Propane
IIB	Ethylene

Gas Group IIB includes all gases for Group IIA

### 3 IGNITION PROTECTION CATEGORIES

Ignition Protection Categories	I.D.	Can Be Used In	Safety Principle
Increased safety	Ex e	Zone 1	No arcs, sparks or hot surfaces
Non-sparking equipment	Ex nA	Zone 2	Controls an internal explosion and extinguishes the flame
Pressurized encapsulation	Ex d	Zone 1	

Junction Box  
Motor

### 5 TEMPERATURE CLASSES

Class	T1	T2	T3	T4	T5	T6
MAXIMUM SURFACE TEMPERATURE						
	450°C	300°C	200°C	135°C	100°C	85°C
IIA	Acetone Ammoniac Benzene Acetic Acid Ethane Ethyl Acetate Ethyl Chloride Methane Methanol Naphthalene Phenol Propane	i-Amylacetate n-Butane n-Butyl Alcohol	Gasolines Diesel Fuels Heating Oils n-Hexane	Acetyl-dehyde	-	-
IIB	Town gas (lighting gas)	Ethylene Ethylene Oxide	Hydrogen Sulfide	Ethylether	-	-

Gas Group IIB, Class t6 includes all specifications for Gas Group IIA, Class T1-T6 and Gas Group IIB, T1-T6

### 6 CONDITIONS & SUBDIVISIONS

Flammable Materials	Temporary Behavior of Explosive Atmosphere	Classification of Hazardous Areas	Group as Defined in Directive 94/9/EC	Equipment Category as Defined in Directive 94/9/EC	Equipment Group as Defined in EN 60079-0	Equipment Protection Level (EPL) as Defined in EN 60079-0
Gases/Vapors	is present continuously or for long periods or frequently	Zone 0	II	1G	II	Ga
	arises in normal operation occasionally	Zone 1	II	2G or 1G	II	Gb or Ga
	is not likely to arise in normal operation, or if it does, will persist for a short time only	Zone 2	II	3G or 2G or 1G	II	Gc or Gb or Ga

# « CERTIFICATION EXPLAINED

## What is ATEX?

**ATEX is the name commonly given to the two European Directives for controlling explosive atmospheres:**

- 1) Directive 99/92/EC (also known as 'ATEX 137' or the 'ATEX Workplace Directive') on minimum requirements for improving the health and safety protection of workers potentially at risk from explosive atmospheres. The text of the Directive and the supporting EU produced guidelines are available on the EU-website.
- 2) Directive 94/9/EC (also known as 'ATEX 95' or 'the ATEX Equipment Directive') on the approximation of the laws of Members States concerning equipment and protective systems intended for use in potentially explosive atmospheres. The text of the Directive and EU produced supporting guidelines are available on the EU website.

## What is an explosive atmosphere?

Dangerous Substances and Explosive Atmospheres Regulations 2002 (DSEAR), defines an explosive atmosphere as a mixture of dangerous substances with air, under atmospheric conditions, in the form of gases, vapors, mist or dust in which, after ignition has occurred, combustion spreads to the entire unburned mixture. Atmospheric conditions are commonly referred to as ambient temperatures and pressures. That is to say temperatures of  $-20^{\circ}\text{C}$  to  $40^{\circ}\text{C}$  and pressures of 0.8 to 1.1 bar.

## Likelihood of Presence: Zone 1

Ignitable concentrations of flammable gases or vapors which are likely to occur under normal operating conditions.

## Group IIB

The Zone System defines the type of hazardous gas and the location of the surrounding atmosphere. Group I contains explosive gasses that naturally occurring in mines. Group II contains explosive gasses found in atmospheres other than mines. Group III contains explosive dust atmospheres. Groups II and III are further defined by the level of hazard for each group marked by an A, B or C with each letter corresponding to a more explosive material than the previous letter. Equipment that is safe to use in Group B is also safe to use in group A but not in group C.

**Group A** - Atmospheres containing propane, acetone, benzene, butane, methane, petrol, hexane, paint solvents or gases and vapors of equivalent hazard.

**Group B** - Atmospheres containing ethylene, propylene oxide, ethylene oxide, butadiene, cyclopropane, ethyl ether, or gases and vapors of equivalent hazard.

Zone system Group IIB is equivalent to Class/Division system Class I, Group C.

## Temperature Code (T Code)

A mixture of hazardous gases and air may be ignited by coming into contact with a hot surface. The conditions under which a hot surface will ignite a gas depends on surface area, temperature, and the concentration of the gas. The maximum possible surface temperature of equipment is shown in the ATEX Explosion Classification as a "t" Value, ranging from T1 to T6 in order of decreasing value (so T6 is "safer").  **$T6 \leq 85^{\circ}\text{C}/185^{\circ}\text{F}$**

## Ignition Source: Electrical

There are two general sources of ignition, from an electrical source and from a non-electrical source. Examples of specific electrical sources include arcing between contacts of a switch or breakdown between traces on a printed wiring board. Examples of non-electrical sources include the hot surfaces of a brake or electrostatic charging of a non-metallic fluid handling system.

## Protection Techniques

Protection Techniques refers to the methods used to protect electrical and non-electrical sources from igniting an explosive atmosphere. These methods are defined in national, regional, and international codes and standards.

### **Flameproof 'd'**

Flameproof, 'd' is a type of protection where the enclosure will withstand an internal explosion of a flammable mixture that has penetrated into the interior, without suffering damage and without causing ignition, through any joints or structural openings in the enclosure, of an external gas atmosphere consisting of one or more of the gases or vapors for which it is designed.

### **Increased Safety 'e'**

Increased Safety, 'e' is a type of protection applied to electrical equipment that does not produce arcs or sparks in normal service and under specified abnormal conditions, in which additional measures are applied so as to give increased security against the possibility of excessive temperatures and of the occurrence of arcs and sparks.

# «CLASSIFICATION

## ATEX Zone Classification

Hazardous areas are classified into zones based on an assessment of the frequency of occurrence and duration of a potentially explosive gas atmosphere. IEC60079-10-1 defines the areas in an explosive atmosphere as:

« Explosive atmosphere: mixture with air, under atmospheric conditions, flammable substances in the form of gas, vapor, dust, fibers, or flyings which, after ignition, permits self-sustaining propagation

« **Zone 0:** an area in which an explosive gas atmosphere is continuously present, for long periods or frequently.

« **Zone 1:** an area in which an explosive gas atmosphere is likely to occur in normal operation occasionally.

« **Zone 2:** area in which an explosive gas atmosphere is not likely to occur in normal operation but, if it does occur, will persist for a short period only.

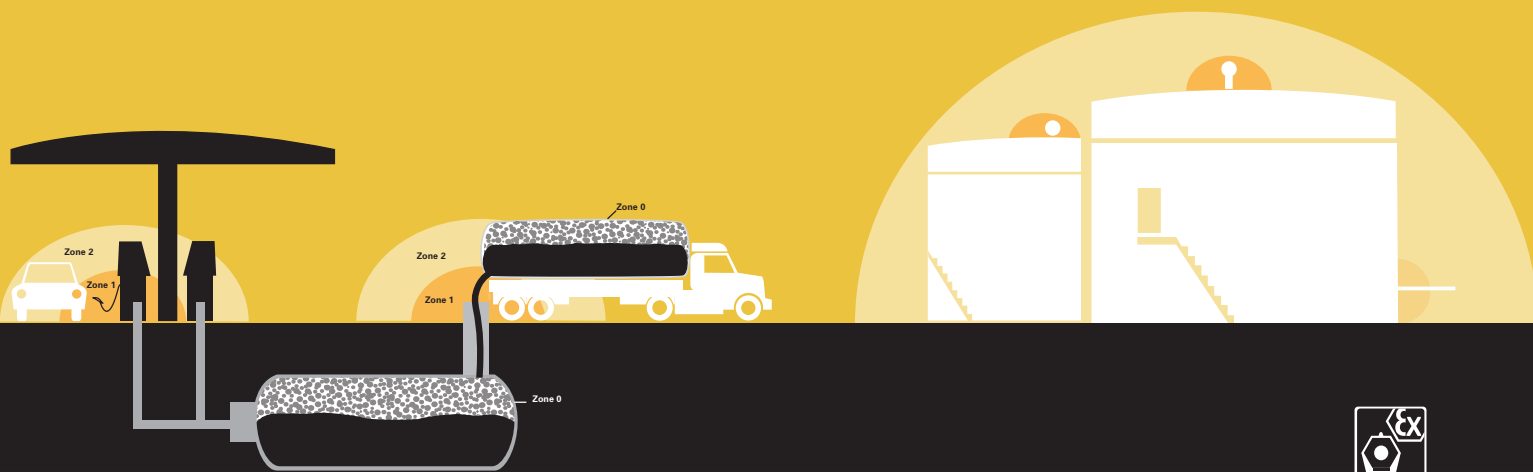

# «WHAT IS CERTIFIED?

## Equipment Certification VS Motor Only Certification

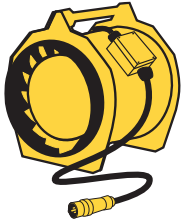

### Equipment Certification



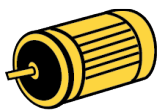



requires all components along the electrical path to be designed and constructed to function safely in potentially explosive atmospheres. All aspects and requirements of explosion protection equipment have been fulfilled according to the directive. The equipment is ready for use based on the instructions of the manufacturer and installation requirements.



**Motor Only Certification** is one component of the equipment that is certified. It ensures that the motor is designed and constructed for safe use in explosive atmospheres for its intended purpose, which may be portable or fixed. However, the ventilation equipment is not ready for use in potentially explosive atmospheres until the whole unit has been certified. It is unsafe because an explosion can still occur from other components used in the equipment!

### Whole Unit Certified

#### Certified Components of the Equipment Certified Ventilators

CERTIFIED COMPONENTS	CERTIFICATE NO.
 HOUSING	UL94 V-0 EN-60079-0 Anti-Static
 MOTOR	DEMKO 03 ATEX 134885U DEMKO 03 ATEX 134885U UL-BR 12.0360 U IECEx UL 12.0034U
 JUNCTION BOX	PTB 00 ATEX 1063 Sup 4 IECEx PTB 08.0006 MC, AEX-8502-X
 CABLE GLAND	IECEX BV507.0020X
 POWER CABLE	H07RN-F No. PL/07/200 UL 62 SOOW No. E146118 CSA 22.2 49 SOOW No. 237374 CE 2006/95/EC RoHS EN 2002/95/EC
 POWER PLUG	LCIE 02 ATEX 6068









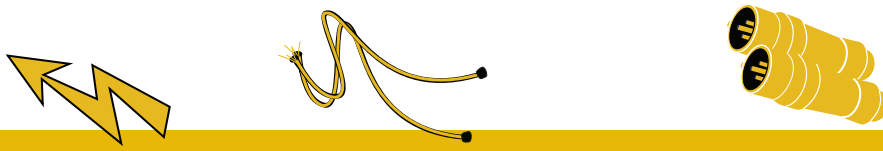

WHOLE UNIT CERTIFIED	CERTIFICATE NO.
 EQUIPMENT	IECEx UL Certificate #: 13.0062X EC-Type Examination Certificate #: DEMKO 09 ATEX 0926969X INMETRO Certificate #: UL-BR 13.0593X CE Hazardous Location Marking: CE0539 Ingress Protection: IP55

### Safety Inspection for Ventilators used in Potentially Explosive Atmospheres

	Yes	No
1. Is the equipment certified safe for use in Zone 1 where potentially explosive substances are LIKELY to be present?	<input checked="" type="checkbox"/>	<input type="checkbox"/>
2. Is the switch located in flameproof enclosure?	<input checked="" type="checkbox"/>	<input type="checkbox"/>
3. Does the equipment have a certified junction box?	<input checked="" type="checkbox"/>	<input type="checkbox"/>
4. Does the equipment have a certified cable gland?	<input checked="" type="checkbox"/>	<input type="checkbox"/>
5. Does the equipment have a certified power cord?	<input checked="" type="checkbox"/>	<input type="checkbox"/>
6. Does the equipment have a certified motor?	<input checked="" type="checkbox"/>	<input type="checkbox"/>
7. Does the equipment use a certified power plug?	<input checked="" type="checkbox"/>	<input type="checkbox"/>
8. Does the equipment have a certified housing?	<input checked="" type="checkbox"/>	<input type="checkbox"/>
9. Is the housing flame retardant?	<input checked="" type="checkbox"/>	<input type="checkbox"/>
10. Is the housing conductive?	<input checked="" type="checkbox"/>	<input type="checkbox"/>
11. Does the motor have a thermal cutoff switch?	<input checked="" type="checkbox"/>	<input type="checkbox"/>
12. Does the equipment have the highest temperature class rating(T6)?	<input checked="" type="checkbox"/>	<input type="checkbox"/>
13. Is the equipment certified by an independent third party?	<input checked="" type="checkbox"/>	<input type="checkbox"/>
14. Motor certified for use with flexible cable?	<input checked="" type="checkbox"/>	<input type="checkbox"/>

# «HOW TO ORDER ELECTRIC FANS Refer to page 10 for ordering information



Voltage	Cable Lengths	Plug Types
<input type="checkbox"/> <b>115V</b>	<input type="checkbox"/> Standard <input type="checkbox"/> 50 ft (15.2 m) <input type="checkbox"/> 100 ft (30.4 m) Additional lengths available upon request	<input type="checkbox"/> <b>Appleton A.T.X. 100/130V</b>  
		<input type="checkbox"/> <b>Killark HazLoc 125V</b>  
<input type="checkbox"/> <b>230V</b>	<input type="checkbox"/> Standard <input type="checkbox"/> 50 ft (15.2 m) <input type="checkbox"/> 100 ft (30.4 m) Additional lengths available upon request	<input type="checkbox"/> <b>Appleton A.T.X. 200/250V</b>  
		<input type="checkbox"/> <b>CEAG ATEX 200/250V</b>  
		<input type="checkbox"/> <b>STAHL ATEX 200/250V</b>  

Additional Plugs available upon request. Please contact Customer Service with country of operations. Plug must meet voltage and amperage requirements of the fan.

## Cable Lengths

**WARNING:** Do not exceed cable length limitations per cable.

Voltage drops occurs along the length of a cable. The longer the cable the greater the drop. Heavier wire, which conducts more electricity, is used to counter the voltage drop. See cable lengths and gauge requirements below. We don't supply cable diameter greater than 12AWG/4 mm<sup>2</sup>.

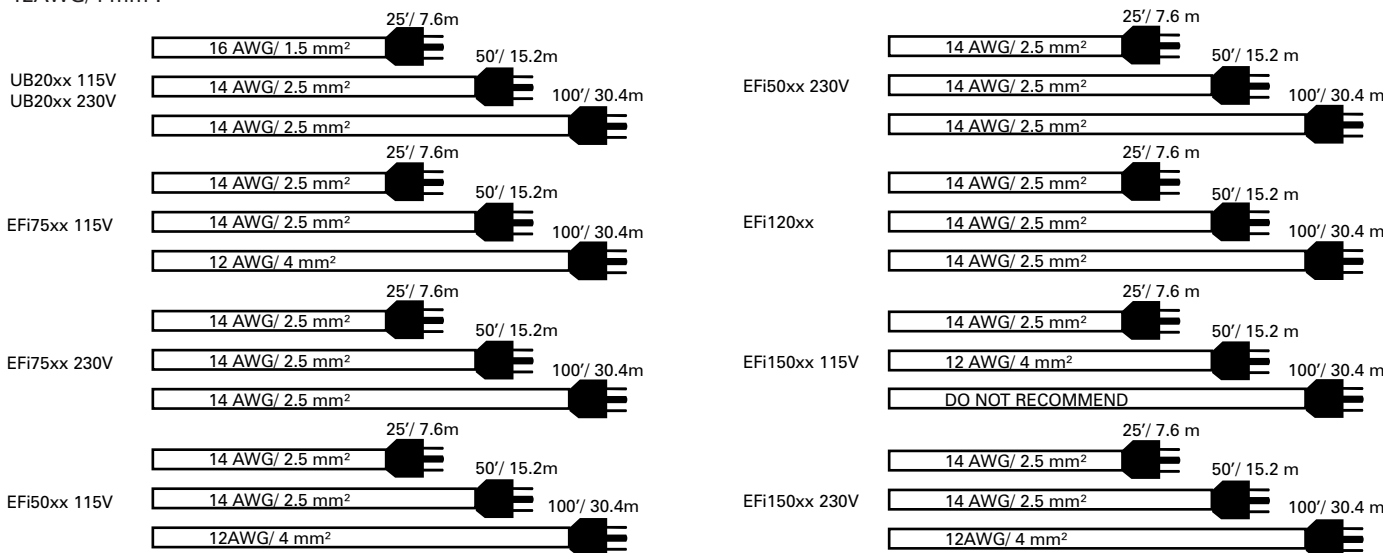



# «PRODUCT SELECTION GUIDE

1

## Energy Source

Electric

*Quick Operation  
Clean Atmosphere*

Compressed Air

*Intrinsically Safe*

2

## Airflow Requirements

### ■ DUCTED AIRFLOW

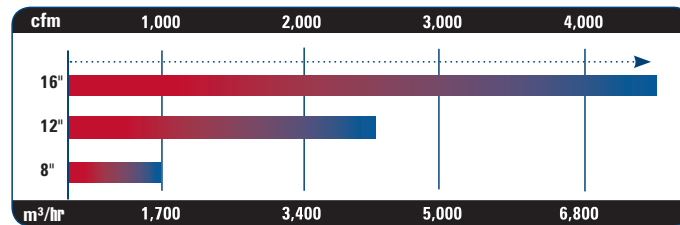

3

## Sizes Available

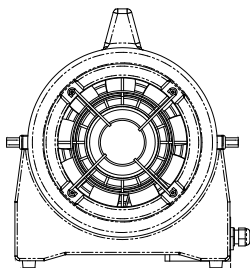

**8"/20 cm**

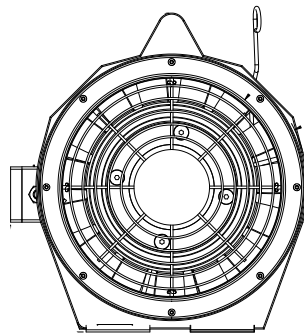

**12"/30 cm**

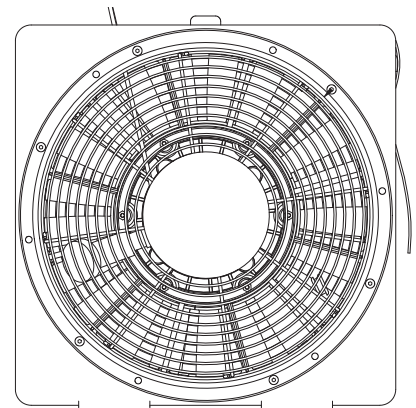

**16"/40 cm**

# «RAMFAN® ELECTRIC Hazardous Location Blowers/Exhausters

Euramco offers a comprehensive selection of explosion proof blowers designed and manufactured for use in hazardous atmospheres to meet the standards specified by the ATEX Directive 94/9/EC, IECEx, CE, INMETRO or UL. See individual fans for certifications.

All explosion proof ventilators are made with tough, chemical resistant, anti-static housing. Choose intrinsically safe pneumatic or certified electric fans with IP55 water resistant switch enclosures. The axial fans range in size to ventilate small to large spaces.

All fans come with integrated duct adapters that easily connect to ECKOFlex™ conductive ducting to provide safe transfer of air and gases from end to end.



## Explosion Proof. Certified

Compliance certifications have always been a critical part of our product development strategy, and we were an early adopter of explosion proof certifications for our purpose-built hazardous location air movers.

Today, our commitment to delivering full-unit certified, explosion proof ventilation solutions, remains unmatched, and we continue to build on this foundation by adding new innovative products as well as international certifications to better serve our customers in different regions of the world.

Our ventilators currently hold full-unit hazardous location certifications for ATEX, IECEx and INMetro.

While various standards exist that are in line with IEC 60079 Standard on Explosive Atmospheres, countries use these standards in their regulations in different ways. Some are making the standards mandatory through legislative act, others are making compliance with the standards a means of proving compliance with the essential health and safety requirements laid out in the legislation, while a third group relies heavily on the

self-correcting nature of the chain of liability where few mandatory elements of the standard exist.

This provides a challenging global operating environment for a manufacturer, but these barriers are critical to surmount to maximize the safety of the users and facilities in which our equipment operates.



### UB20xx 8\"/>

Compact and lightweight while delivering the highest CFM available in its class. Use with fan for exhaust or suction. Ultra-quiet operation at 74 dB. Power cable is 25' (7.6 m) long for extended reach. Integrated duct adapters to easily connect to anti-static duct.

**Optional anti-static Quick-Couple™** Canister stores and protects conductive duct from rips and tears. Integrated into the UB20xx blower for fast and convenient set-up.

	UB20xx (115V)	UB20xx (230V)
<b>Order No#</b>	EF7002	EF8002
<b>Motor</b>	0.33 Hp (0.25 kW)	0.33 Hp (0.25 kW)
<b>Power</b>	115V, 1ø, 50/60Hz	230V, 1ø, 50/60Hz
<b>Free Air Through Duct</b>	980 cfm (1,666 m³/hr)	819 cfm (1,392 m³/hr)
15'/4.6 m w/ one 90° turn:	789 cfm (1,341 m³/hr)	659 cfm (1,120 m³/hr)
15'/4.6 m w/ two 90° turns:	666 cfm (1,132 m³/hr)	558 cfm (948 m³/hr)
25'/7.6 m w/ one 90° turn:	722 cfm (1,227 m³/hr)	603 cfm (1,025 m³/hr)
25'/7.6 m w/ two 90° turns:	614 cfm (1,044 m³/hr)	510 cfm (867 m³/hr)
<b>Weight</b>	27 lbs (12 kg)	27 lbs (12 kg)

### Efi75xx 12\"/>

Supply fresh air and exhaust hazardous/explosive gases safely. Integrated duct adapters to easily connect to anti-static duct.

	Efi75xx
<b>Order No#</b>	EB7201XX, EB7201XX-230, EB7201XX-AFNOR
<b>Motor</b>	0.75 Hp (0.56 kW)
<b>Power</b>	115/230V, 1ø, 50/60Hz
<b>Free Air Through Duct</b>	2,500 cfm (4,250 m³/hr)
15'/4.6 m w/ one 90° turn:	1,664 cfm (2,829 m³/hr)
15'/4.6 m w/ two 90° turns:	1,529 cfm (2,599 m³/hr)
<b>Weight</b>	44 lbs (20 kg)



### Efi50xx/Efi120xx/Efi150xx 16\"/>

The largest hazardous location blowers for highest volume of air movement. Use the Efi50xx (0.5 Hp) when you need a high volume, low velocity, somewhat gentler flow; or the Efi150xx (1.5 Hp) model for higher velocities, increased volumes and reduced purge or cooling times. 16" (40 cm) integrated duct adapters. Stackable in storage or during operation.

	Efi50xx*	Efi120xx	Efi150xx
<b>Order No#</b>	EA8000XX, EA8000XX-230	EA8120XX, EA8120XX-110	EG8200XX, EG8200XX-230
<b>Motor</b>	0.5 Hp (0.37 kW)	1.2 Hp (0.9 kW)	1.5 Hp (1.1 kW)
<b>Power</b>	115/230V, 1ø, 50/60Hz	110/240V, 1ø, 50Hz	115/230V, 1ø, 50/60Hz
<b>Free Air Through Duct</b>	3,200 cfm (5,440 m³/hr)	3,750 cfm (6,375 m³/hr)	4,459 cfm (7,580 m³/hr)
15'/4.6 m w/ one 90° turn:	1,935 cfm (3,289 m³/hr)	2,700 cfm (4,590 m³/hr)	3,179 cfm (5,404 m³/hr)
<b>Weight</b>	49 lbs (22 kg)	55 lbs (25 kg)	61 lbs (28 kg)

\*Certified Motor Only

# COMPRESSED AIR | Hazardous Location Blowers/Exhausters & Accessories

Intrinsically safe pneumatic ventilators are made with tough, chemical resistant, anti-static housing. Each model comes complete with filter, motor lubricator, exhaust muffler, air control valve and static grounding cord. Both models have integrated duct adapters that connect to ECKOFlex™ conductive ducting to provide safe transfer of air and gases from end to end.



### AFi75xx 12"/30 cm

Compact, air driven ventilator. Pneumatic motor exhausts outside of duct, compressed air is not in airstream.

	AFi75xx
Order No#	AB7000
Motor	GAST 4AM-NRV-50C
Free Air	2,042 cfm (3,471 m <sup>3</sup> /hr ) @ 80psig inlet air
Weight	38 lbs (17 kg)

### AFi50xx 16"/40 cm

Large, air driven ventilator is stackable in storage or during operation. Exhausts outside of duct, compressed air not in airstream.

	AFi50xx
Order No#	AA7000
Motor	GAST 4AM-NRV-50C
Free Air	3,200 cfm (5,440 m <sup>3</sup> /hr) @ 80psig inlet air
Weight	43 lbs (20 kg)



### RV760S/RV760/RV1500 Venturi Cones

Pneumatic (compressed air) or saturated steam powered venturi cones for safe use in adverse or explosive atmospheres when used with optional static grounding cord. Requires minimum maintenance. Cones are crush and dent resistant. Cylindrical mixing chamber delivers higher induction ratios and fits standard API 3" (7 cm) and 6" (15 cm) openings.

	RV760S (3"/7 cm)	RV760 (3"/7 cm)	RV1500 (6"/15 cm)
Order No#	RV760S	RV760	RV1500
<b>40PSIG INLET AIR</b>			
Free Air	810 cfm (1,377 m <sup>3</sup> /hr)	1,001 cfm (1,702 m <sup>3</sup> /hr)	2,740 cfm (4,658 m <sup>3</sup> /hr)
Air Consumption	22 cfm (37 m <sup>3</sup> /hr)	22 cfm (37 m <sup>3</sup> /hr)	59 cfm (100 m <sup>3</sup> /hr)
Induction Ratio	37:1	46:1	47:1
<b>80PSIG INLET AIR</b>			
Free Air	1,180 cfm (2,006 m <sup>3</sup> /hr)	1,439 cfm (2,446 m <sup>3</sup> /hr)	3,329 cfm (5,659 m <sup>3</sup> /hr)
Air Consumption	58 cfm (99 m <sup>3</sup> /hr)	58 cfm (99 m <sup>3</sup> /hr)	124 cfm (211 m <sup>3</sup> /hr)
Induction Ratio	20:1	20:1	27:1
Weight	5lbs (2 kg)	6 lbs (3 kg)	19 lbs (9 kg)

## « ACCESSORIES



### UB20xx M.E.D.™ (Manhole Entry Device)

Order# EF7015-MEDXX (UB20XX 115V/60 Hz)

Order# EF8015-MEDXX (UB20XX 230V/50 Hz)

Anti-static system ventilates without blocking the entry to maintain airflow while working and permits rapid entry and exit.

Package includes: UB20xx fan, Quick-couple canister with conductive duct, M.E.D.™, 90° elbow, and universal mount.

#### Components:

Order# MED5100XX - M.E.D., elbow, mount (no blower)

Order# MED189XX - M.E.D.

Order# MED90XX - elbow

Order# MEDUM - mount



### UB20xx with Quick Couple™ Canister

Order# EF7015 - (60Hz) Quick-Couple™ Canister w/ 15'/4.6 m duct

Order# EF7025 - (60Hz) Quick-Couple™ Canister w/ 25'/7.6 m duct

Order# EF8015- (50Hz) Quick-Couple™ Canister w/ 15'/4.6 m duct

Order# EF8025 - (50Hz) Quick-Couple™ Canister w/ 25'/7.6 m duct

Quickly connect two or more RAMFAN UB20 axial blowers in series increases airflow up to 50% when blowing through long and windy duct runs. Long, windy duct runs need more power and pressure to deliver sufficient airflow, a costly proposition. The Turbo-Couple™ delivers what is needed by quickly joining two or more UB20's in series.

### Quick Couple™ Canister with Conductive Duct

Order# EF7004CS - Quick-Couple Canister™ with 15' (4.6 m) conductive duct

Order# EF7004CL - Quick-Couple Canister™ with 25' (7.6 m) conductive duct

Order# EF7004CL/DS - Quick-Couple™ Canister w/ (2pcs) 5'/1.5 m and 15'/4.6 m duct



### Static Cord for Venturi Cones

Order# AZ-RAC-10



### Duct Adapter/Reducer 12"-8"

Order# EC031

For EF175xx and AF175xx

### Duct Couplers

DC8 - 8"/20 cm duct coupler

DC12 - 12"/30 cm duct coupler

DC16 - 16"/40 cm duct coupler

### Anti-Static Duct & Storage Bags

Collapsible reinforced duct is flame retardant. Each duct comes with its own bag.

Order# FDT-0815CBB - 8"/20 cm diameter duct, 15'/4.6 m with storage bag

Order# FDT-0825CBB - 8"/20 cm diameter duct, 25'/7.6 m with storage bag

Order# FDT-1215CBB - 12"/30 cm diameter duct, 16'/5 m with storage bag

Order# FDT-1225CBB - 12"/30 cm diameter duct, 32'/10 m with storage bag

Order# FDT-1615CBR - 16"/40 cm diameter duct, 15'/4.6 m with storage bag

Order# FDT-1625CBR - 16"/40 cm diameter duct, 25'/7.6 m with storage bag



### Replacement Duct for Quick-Couple™ Canister

Order# FDT-0805CCB - 8"/20 cm x 5'/1.5 m

Order# FDT-0815CRX - 8"/20 cm x 15'/4.6 m

Order# FDT-0825CRX - 8"/20 cm x 25'/7.6 m

### Storage Bags

Order# BG8 - 8"/20 cm duct storage bag

Order# BG12 - 12"/30 cm duct storage bag

Order# BG16 - 16"/40 cm duct storage bag



## Applications

- FlowPath™ Control
- Large Structure Ventilation - LSV
- Smoke Ejectors

# «PRODUCT SELECTION GUIDE

1

## Energy Source

Gas

*Best Performance  
Best Portability*

Electric

*Quick Operation  
Clean Atmosphere*

Battery

*Quick Operation  
Clean Atmosphere  
Portable*

Water

*Intrinsically Safe  
Clean Atmosphere*

2

## Airflow Requirements

### DUCTED AIRFLOW

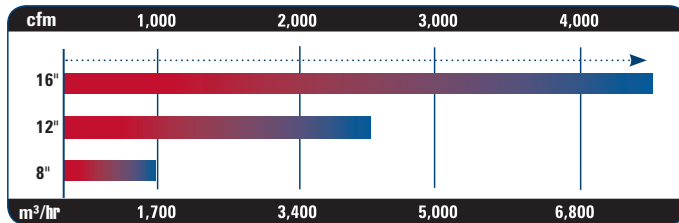

### PPV AIRFLOW

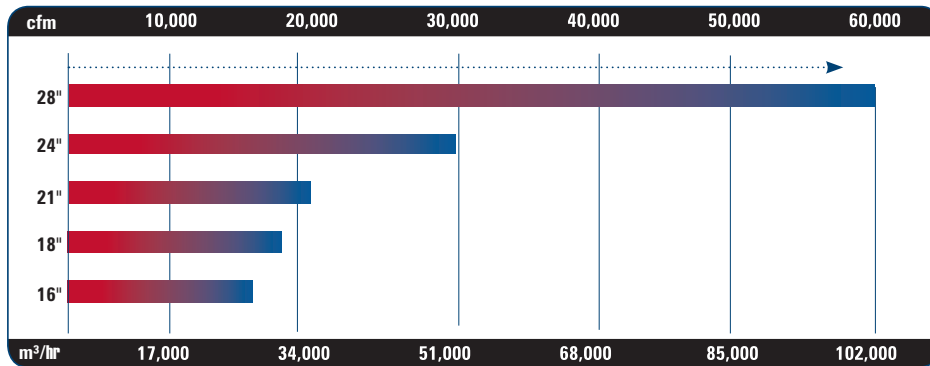

3

## Sizes Available

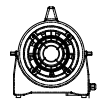

8"/20 cm

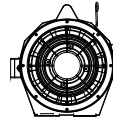

12"/30 cm

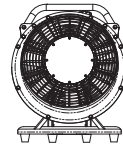

16"/40 cm

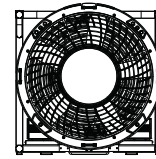

18"/46 cm

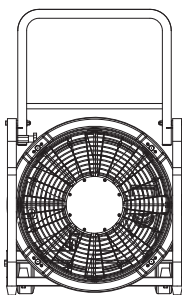

21"/54 cm

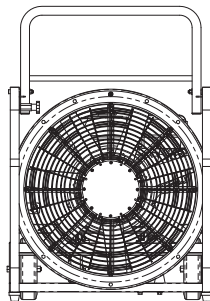

24"/60 cm

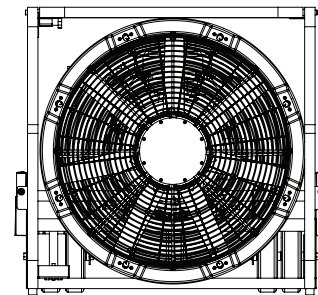

28"/70 cm

# « RAMFAN® ELECTRIC Confined Space Rescue

## Confined Space Ventilators

Confined space rescues require additional considerations to perform a rescue. In addition to general risks there is a danger of asphyxiation (lack of oxygen), poisoning, or fire and explosion. A fan can be used during confined space rescue to combat the additional risks.

Ventilation can be performed by supplying or exhausting air or both. The weight and characteristics of the atmospheric hazard as well as the environmental conditions of the general area will dictate the type(s) of ventilation applied. Using a blower that can be used in positive or negative pressure ventilation is ideal. The safest option is to use the UB20xx explosion proof ventilator. It prevents a source of ignition in a flammable environment.

In addition to the fan, consider an assortment of duct and Manhole Entry Device (M.E.D.). The M.E.D. will permit access through the manhole without interrupting airflow. Spaces that are deep may require extensive duct work. Multiple fans used in different configurations may be required. The more options you have, the better equipped you will be to address the problem.



**SAFE**

	UB20 (115V)	UB20 (230V)	UB20 (12V DC)
<b>Order No#</b>	ED7002	ED8002	ED9002
<b>Motor</b>	0.33 Hp (0.25 kW)	0.33 Hp (0.25 kW)	0.25 Hp (0.19 kW)
<b>Power</b>	115V, 1ø, 50/60Hz	230V, 1ø, 50/60Hz	12VDC
<b>Free Air</b>	980 cfm (1,666 m³/hr)	819 cfm (1,392 m³/hr)	862 cfm (1,465 m³/hr)
<b>Through Duct</b>			
15'/4.6 m w/ one 90° turn:	789 cfm (1,341 m³/hr)	659 cfm (1,120 m³/hr)	695 cfm (1,181 m³/hr)
15'/4.6 m w/ two 90° turns:	666 cfm (1,132 m³/hr)	558 cfm (948 m³/hr)	586 cfm (996 m³/hr)
25'/7.6 m w/ one 90° turn:	722 cfm (1,227 m³/hr)	603 cfm (1,025 m³/hr)	
25'/7.6 m w/ two 90° turns:	614 cfm (1,044 m³/hr)	510 cfm (867 m³/hr)	
<b>Weight</b>	17 lbs (8 kg)	17 lbs (8 kg)	17 lbs (8 kg)

	UB20xx (115V)	UB20xx (230V)
<b>Order No#</b>	EF7002	EF8002
<b>Motor</b>	0.33 Hp (0.25 kW)	0.33 Hp (0.25 kW)
<b>Power</b>	115V, 1ø, 50/60Hz	230V, 1ø, 50/60Hz
<b>Free Air</b>	980 cfm (1,666 m³/hr)	819 cfm (1,392 m³/hr)
<b>Through Duct</b>		
15'/4.6 m w/ one 90° turn:	789 cfm (1,341 m³/hr)	659 cfm (1,120 m³/hr)
15'/4.6 m w/ two 90° turns:	666 cfm (1,132 m³/hr)	558 cfm (948 m³/hr)
25'/7.6 m w/ one 90° turn:	722 cfm (1,227 m³/hr)	603 cfm (1,025 m³/hr)
25'/7.6 m w/ two 90° turns:	614 cfm (1,044 m³/hr)	510 cfm (867 m³/hr)
<b>Weight</b>	27 lbs (12 kg)	27 lbs (12 kg)



**SAFEST**

## « ACCESSORIES



### Standard Duct

Order# FDT-21624046BR  
8'/20 cm x 15'/4.6 m

Order# FDT-21624076BR  
8'/20 cm x 25'/7.6 m



### Quick-Couple™ Canister

Order # ED7004CS  
Quick-Couple Canister with 15' (4.6 m)  
Standard duct

Order # ED7004CL  
Quick-Couple Canister with 25' (7.6 m)  
Standard duct

Order# ED7004CL/DS - Quick-Couple™ Canister w/ (2pcs) 5'/1.5 m and 15'/4.6 m duct



### Anti-static Duct

Order# FDT-0815CBB  
8'/20 cm x 15'/4.6 m

Order# FDT-0825CBB  
8'/20 cm x 25'/7.6 m



### Quick-Couple™ Canister

Order # EF7004CS  
Quick-Couple Canister with 15' (4.6 m)  
conductive duct

Order # EF7004CL  
Quick-Couple Canister with 25' (7.6 m)  
conductive duct

Order# EF7004CL/DS - Quick-Couple™ Canister w/ (2pcs) 5'/1.5 m and 15'/4.6 m duct



## High Volume Confine Space Ventilators

Proper ventilation in confined spaces is essential for a safe work environment. Atmospheric hazards cause approximately 90% of worker injuries and fatalities in confined spaces. Ventilation of a confined space should be done to stabilize the environment. This could be to replace the bad air, make the air breathable, get rid of toxic vapors, make the area warmer or cooler, remove dust and so on.

The larger the confined space the more powerful ventilator you will need. The RAMFAN UB30 is a high power ventilation unit moving up to 2,420 cfm (4,114 m<sup>3</sup>/hr) of air for use in confined spaces. Constructed from ultra durable polymer to stand up to rugged work environments. The fan will provide reliable exhaustion or ventilation on the job site.



**SAFE**

	UB30 (115V)	UB30 (230V)
<b>Order No#</b>	EJ4002	EJ8002
<b>Motor</b>	1 Hp (0.75 kW)	1 Hp (0.75 kW)
<b>Power</b>	115V, 1ø, 50/60Hz	230V, 1ø, 50/60Hz
<b>Free Air</b>	2,420 cfm (4,114 m <sup>3</sup> /hr)	2,017 cfm (3,429 m <sup>3</sup> /hr)
<b>Through Duct</b>		
15/4.6 m w/ no turns:	2,250 cfm (3,485 m <sup>3</sup> /hr)	1,650 cfm (2,805 m <sup>3</sup> /hr)
15/4.6 m w/one 90° turn:	2,050 cfm (3,485 m <sup>3</sup> /hr)	1,500 cfm (2,550 m <sup>3</sup> /hr)
15/4.6 m w/ two 90° turns:	1,875 cfm (3,188 m <sup>3</sup> /hr)	1,376 cfm (2,340 m <sup>3</sup> /hr)
25/7.6 m w/ one 90° turn:	1,825 cfm (3,103 m <sup>3</sup> /hr)	1,400 cfm (2,380 m <sup>3</sup> /hr)
25/7.6 m w/ two 90° turns:	1,750 cfm (2,975 m <sup>3</sup> /hr)	1,324 cfm (2,250 m <sup>3</sup> /hr)
<b>Weight</b>	37 lbs (17 kg)	37 lbs (17 kg)

### EFi75xx (12"/30 cm)

<b>Order No#</b>	EB7201XX, EB7201XX-230
<b>Motor</b>	0.75 Hp (0.56 kW)
<b>Power</b>	115/230V, 1ø, 50/60Hz
<b>Free Air</b>	2,500 cfm (4,250 m <sup>3</sup> /hr)
<b>Through Duct</b>	
15/4.6 m w/ one 90° turn:	1,664 cfm (2,829 m <sup>3</sup> /hr)
15/4.6 m w/ two 90° turns:	1,529 cfm (2,599 m <sup>3</sup> /hr)
<b>Weight</b>	44 lbs (20 kg)

**SAFEST**



## ACCESSORIES



### Standard Duct

12"/30 cm x 16'/5 m  
Order# FDT-30534005BB

12"/30 cm x 32'/10 m  
Order# FDT-30534010BB



### Anti-static Duct

12"/30 cm x 15'/4.6 m  
Order# FDT-1215CBB

12"/30 cm x 25'/7.6 m  
Order# FDT-1225CBB



Confined Space Rescue

# « RAMFAN® ELECTRIC Smoke Ejectors

EFi50xx/EFi120xx/EFi150xx

## SAFEST



Euramco Safety's specialty. Certified explosion-proof portable ventilators.			
	EFi50xx* (16"/40 cm)	EFi120xx (16"/40 cm)	EFi150xx (16"/40 cm)
Order No#	EA8000XX, EA8000XX-230	EA8120XX, EA8120XX-110	EG8200XX, EG8200XX-230
Motor	0.5 Hp (0.37 kW)	1.2 Hp (0.9 kW)	1.5 Hp (1.1 kW)
Electric	115/230V, 1ø, 50/60Hz	110/240V, 1ø, 50Hz	115/230V, 1ø, 50/60Hz
Free Air Through Duct 15/4.6 m w/ one 90° turn:	3,200 cfm (5,440 m³/hr) 1,935 cfm (3,289 m³/hr)	3,750 cfm (6,375 m³/hr) 2,700 cfm (4,590 m³/hr)	4,459 cfm (7,580 m³/hr) 3,179 cfm (5,404 m³/hr)
Weight	49 lbs (22 kg)	55 lbs (25 kg)	61 lbs (28 kg)

\*Certified Motor Only

EFC50x/EFC120x/EFC150x

## SAFER

Heat-resistant Lexan® housing, and use an explosion-proof motor			
	EFC50x (16"/40 cm)	EFC120x (16"/40 cm)	EFC150x (16"/40 cm)
Order No#	EA7000X, EA7000X-230	EA7300X	EG8000X, EG8000X-230
Motor	0.5 Hp (0.37 kW)	1.2 Hp (0.9 kW)	1.5 Hp (1.1 kW)
Electric	115/230V, 1ø, 50/60Hz	230V, 1ø, 50Hz	115/230V, 1ø, 50/60Hz
Free Air Through Duct 15/4.6 m w/ one 90° turn:	3,200 cfm (5,440 m³/hr) 1,935 cfm (3,289 m³/hr)	3,750 cfm (6,375 m³/hr) 2,700 cfm (4,590 m³/hr)	4,459 cfm (7,580 m³/hr) 3,179 cfm (5,404 m³/hr)
Weight	49 lbs (22 kg)	55 lbs (25 kg)	55 lbs (25 kg)



EFC50/EFC120/EFC150

## SAFE



Heat-resistant Lexan® housing			
	EFC50 (16"/40 cm)	EFC120 (16"/40 cm)	EFC150 (16"/40 cm)
Order No#	EA7000, EA7000-230	EA7300	EG8000, EG8000-230
Motor	0.5 Hp (0.37 kW)	1.2 Hp (0.9 kW)	1.5 Hp (1.1 kW)
Electric	115/230V, 1ø, 50/60Hz	230V, 1ø, 50Hz	115/230V, 1ø, 50/60Hz
Free Air Through Duct 15/4.6 m w/ one 90° turn:	3,200 cfm (5,440 m³/hr) 1,935 cfm (3,289 m³/hr)	3,750 cfm (6,375 m³/hr) 2,700 cfm (4,590 m³/hr)	4,459 cfm (7,580 m³/hr) 3,179 cfm (5,404 m³/hr)
Weight	49 lbs (22 kg)	55 lbs (25 kg)	55 lbs (25 kg)

«ACCESSORIES

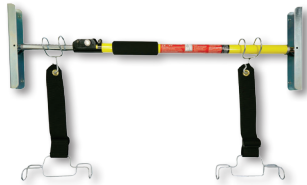

**Door Bar Hanger and Kit**  
 Order# EA7095K (Doorbar and Hanger)  
 Order# EA7092K (Hanger)  
 Order# EA7081 (Doorbar)



**16" (40 cm) Multi-Purpose Accessory Kit**  
 Order# BG16LFA



**Layflat Duct**  
 16"/40 cm, 25/7.6 m unreinforced  
 Order# FDT-1625SME  
 16"/40 cm, 90° unreinforced 4' x 10'  
 Order# FDT-L4X10SME



**Disposable Duct-100' (30.5)**  
 16"/40 cm  
 Order# FDT16DISP



**Tilt Bracket**  
 Order# EA9145

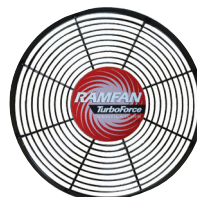

**Duct Adapter/Reducer 16"-40 cm**  
 Inlet side  
 Order# EA7116  
 Outlet side  
 Order# EA7117



**Standard Duct**  
 16"/40 cm x 15/4.6 m  
 Order# FDT-1615BR  
 16"/40 cm x 25/7.6 m  
 Order# FDT-1625BR



**Anti-static Duct**  
 16"/40 cm x 15/4.6 m  
 Order# FDT-1615CBR  
 16"/40 cm x 25/7.6 m  
 Order# FDT-1625CBR



# «RAMFAN® ELECTRIC Blowers/Exhausters



## Stay Unplugged, Indefinitely!

Swappable battery packs with enhanced IP66 water jet protection to protect against the inevitable sweep of the fire hose. The ability to have extra packs ready to go removes the limitations of other battery fan concepts, leading towards full corded fan replacement on the fire ground.

## 40V Lithium Ion Battery Packs

Advanced, High Energy Density 432 Wh Lithium Ion battery system was designed specifically for the high draw and sustained run-time applications demanded of PPV fans.

### PPV

Equipped with 2nd generation *PowerStream®* airflow straighteners for flexible positioning, reduced noise inside the structure and a deeper FlowPath™ through the structure.

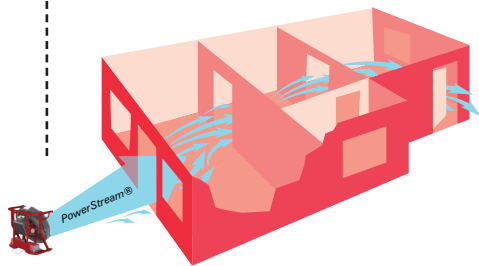

### Smoke Ejection

Perfectly balanced to hang from a doorbar during smoke ejection



### Confined Space

Used directly on top of an amanhole or connected to duct for rescues in a confined space



### Night Ops

Integrated LED scene lights



### Relay fan during large structure ventilation

Keep the FlowPath™ moving in stairwells or halls

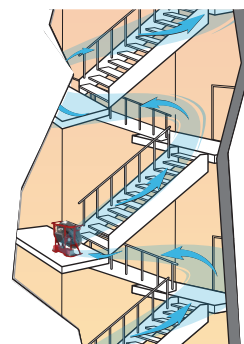

# RAMFAN RE-WRITES THE RULES.

✓ **Swappable Battery Packs - Unlimited Runtime**

✓ **LED Scene Lights - Integrated into Shroud**

✓ **Smoke Ejector Capabilities - Hang from door bar, vent through duct**

✓ **IP66 Protection from Powerful Water Jets**

## ⊕ **Swappable Batteries**

Keep the FlowPath™ going! Don't get stuck with a dead fan or scrambling for an outlet

## ⊕ **Brushless Motor**

Advanced BLDC motor by Euramco Safety has longer motor life and longer run-time

## ⊕ **Advanced FlowPath™ Control**

0-35° tilt with 5 way positioning to create the ideal unobstructed FlowPath thru a structure

## ⊕ **2nd Generation PowerStream**

Air straighteners for further setback

## ⊕ **Optional External Charger**

Mounted in a fire apparatus or at the fire department to rapidly charge two RAMFAN 40V batteries at the same time.

## ⊕ **IP66 Water Resistant**

IP66 rated motor, controller and battery pack

## ⊕ **Scene Lighting**

Light up the night with LED lights standard

## ⊕ **Intellisense™ E2 Controller**

Next generation controller

## ⊕ **Dual Power**

Runs on AC or DC Power

## ⊕ **Lightweight**

Aircraft grade aluminum allow frame is light and durable





## EF SERIES

Powerful Single-Speed electric PPV fan with a powder coated steel frame, all-terrain semi-pneumatic tires and full width retractable handle.

	EF390H (16"/40 cm)
Order No#	EA5403
Motor	2.2 Hp (1.7 kW)
Power	230V, 1ø, 50Hz
PPV Airflow	11,765 cfm (20,001 m <sup>3</sup> /hr)
Weight	78 lbs (35 kg)

## EV SERIES

Variable speed electric PPV fans with continuous airflow adjustment. Built with a powder coated steel frame, all-terrain semi-pneumatic tires, full width retractable handle, and 0-20° tilt for precise positioning.

	EV400 (16"/40 cm)	EV420 (16"/40 cm)
Order No#	EB80500	EB80510, EB81505 (CE)
Motor	1.5 Hp (1.1 kW)	1.5 Hp (1.1 kW)
Power	115V, 1ø, 15A or 20A, 60Hz	EB80510:230VAC, 1ø, 10A, 60Hz EB81505:230VAC, 1ø, 10A, 50Hz
PPV Airflow	11,391 cfm (19,365 m <sup>3</sup> /hr)	10,994 cfm (18,690 m <sup>3</sup> /hr)
Weight	68 lbs (31 kg)	68 lbs (31 kg)



EV400/EV420



EX400/EX420

EX500/EX520

## EX SERIES

The latest variable speed electric PPV fans with PowerStream® air straighteners for greater flow velocities and more flexible setback. Dual Current available on EX400 & EX500 models, with the flip of a switch, power fan from GFCI 20A fire truck circuit to GFCI 15A house circuit. EX500 and EX520 have optional ingratiated misting system.

	EX400 (16"/40 cm)	EX420 (16"/40 cm)	EX500 (18"/46 cm)	EX520 (18"/46 cm)
Order No#	EB80600	EB88245	EK86500	EK86520
Motor	1.5 Hp (1.1 kW)	1.5 Hp (1.1 kW)	1.5 Hp (1.1 kW)	1.5 Hp (1.1 kW)
Power	115V, 1ø, 15A or 20A, 60Hz	230V, 1ø, 10A 50/60Hz	115V, 1ø, 15A or 20A, 60Hz	230V, 1ø, 10A 50/60Hz
PPV Airflow	11,391 cfm (19,365 m <sup>3</sup> /hr)	10,994 cfm (18,690 m <sup>3</sup> /hr)	11,540 cfm (19,618 m <sup>3</sup> /hr)	13,354 cfm (22,702 m <sup>3</sup> /hr)
Weight	68 lbs (31 kg)	68 lbs (31 kg)	70 lbs (32 kg)	70 lbs (32 kg)

## EX SERIES

The latest technology integrated into this all-purpose ventilator with swappable batteries. Use for PPV, Smoke Ejector or Confined Space. Starts instantly on battery power and lasts 45 minutes on max speed or hours on low speed to keep air moving. Integrated LED lights for night ops. Built with aircraft grade, lightweight aluminum frame.

	EX50Li (18"/46 cm)
Order No#	EL5500
Motor	0.8 Hp (0.6 kW)
PPV Airflow	8,939 cfm (15,187m <sup>3</sup> /hr)
Battery System	40V Lithium-ion, 432Wh
Weight	54 lbs (25 kg)



XP400/XP420

XP500/XP520

## XP SERIES

ATEX certified motor to safely purge hazardous gases. Equipped with PowerStream air straighteners for greater setback distances.

	XP400 (16"/40 cm)	XP420 (16"/40 cm)	XP500 (18"/46 cm)	XP520 (18"/46 cm)
Order No#	EB80500X	EB80500X-230	EB90600X	EB90600X-230
Motor	1.5 Hp (1.1 kW)	1.5 Hp (1.1 kW)	1.5 Hp (1.1 kW)	1.5 Hp (1.1 kW)
Power	115V, 1ø, 15A, 50/60Hz	230V, 1ø, 8A 50/60Hz	115V, 1ø, 15A, 50/60Hz	230V, 1ø, 8A 50/60Hz
PPV Airflow	11,391 cfm (19,365 m <sup>3</sup> /hr)	10,994 cfm (17,143 m <sup>3</sup> /hr)	11,540 cfm (19,618 m <sup>3</sup> /hr)	13,354 cfm (22,702 m <sup>3</sup> /hr)
Weight	68 lbs (31 kg)	68 lbs (31 kg)	72 lbs (33 kg)	72 lbs (33 kg)

## ACCESSORIES

NEW



### Battery Charger

Order# R2C-5500AC  
Order# R2C-5500DC  
(EX50Li Only)



### 18"/46 cm Duct Adapter/Reducer

Compatible with 18"/46 cm fan and 16"/40 cm duct  
Order# GH2211  
For use with all 18" (46 cm) fans



### Standard Duct with Storage Bags

16"/40 cm x 15'/4.6 m  
Order# FDT-1615BR  
16"/40 cm x 25'/7.6 m  
Order# FDT-1625BR  
For use with all 16" (40 cm) Fans

NEW



### Vehicle Mount

Order# EL600K  
(EX50Li Only)



### 16" (40 cm) Multi-Purpose Accessory Kit

Order# BG16LFA  
For use with all 16" (40 cm) fans

### Storage Bag Only

Storage Bag for 16" (40 cm)  
Order# BG16

NEW



### 40V Battery Packs

Order# R2-360-AH-U  
(EX50Li Only)  
recommend purchasing 2



### Integrated Misting System

1.85 gal/min@100 psi  
7 l/min@6.9 bar  
Order# GH8112  
(EX500/EX520, XP500/XP5200)



### Layflat Duct

16"/40 cm, 25'/7.6 m  
Order# FDT-1625SME (unreinforced)  
16"/40 cm with a 90° bend  
Order# FDT-L4X10SME (unreinforced)  
For use with all 16" (40 cm) fans



### Cooling Collars/Misters - 16" (40 cm) Blowers

Order# ED-MIST16  
For use with all 16" (40 cm) fans



### Door Bar Hanger and Kit

Order# EL7095K

### Hanger Kit

Order# EL8095  
(EX50Li Only)

Order# EB8111  
(EV400/EV420, EX400/EX420)

### Shoulder Strap

Order# EL6013  
For EX50Li fan



### Disposable Duct- 100' (30.5)

16"/40 cm  
Order# FDT16DISP  
For use with all 16" (40 cm) fans



# GAS | PPV Blowers & Accessories



GX200L



GX200

## ULTRA LIGHTWEIGHT SERIES

RAMFAN offers the lightest PPV fans on the market, providing the ultimate portability. Starting at only 16kg, the GX200L can easily be carried with one hand. Light enough to carry up stairwells and deploy in large commercial buildings or powerful enough for PPV in residential houses. Equipped with *PowerStream*<sup>®</sup> air straighteners.

	GX200L (16"/40 cm)	GX200 (16"/40 cm)
<b>Order No#</b>	GG5500	GG5010
<b>Motor</b>	Honda GXH50 2.1 Hp (1.6 kW)	Honda GXH50 2.1 Hp (1.6 kW)
<b>Run Time</b>	1 hr 40 min	1 hr 40 min
<b>PPV Airflow</b>	12,820 cfm (21,794 m <sup>3</sup> /hr)	12,820 cfm (21,794 m <sup>3</sup> /hr)
<b>Weight</b>	36 lbs (16 kg)	48 lbs (22 kg)

## GF SERIES

Tried and True the GF series have been around since RAMFAN got its start. The economical gas fans are well known for their durability.

	GF164SE (16"/40 cm)	GF165 (16"/40 cm)	GF165SE (16"/40 cm)	GF210 (21"/54 cm)
<b>Order No#</b>	GB5001HSE GB5003HSE (CCC Certified China)	GA5006	GA5006SE	GE5001
<b>Motor</b>	Honda GC160 4.6 Hp (3.4 kW)	Honda GX160 4.8 Hp (3.5 kW)	Honda GC Series 5 Hp (3.7kW)	Honda GX160 4.8 Hp (3.5 kW)
<b>Run Time</b>	1 hr 58 min	2 hrs 6 min	1 hr 58 min	1 hrs 26 min
<b>PPV Airflow</b>				
<b>Single Door</b>	11,653 cfm (19,810 m <sup>3</sup> /hr)	12,906 cfm (21,940 m <sup>3</sup> /hr)	11,815 cfm (20,085 m <sup>3</sup> /hr)	17,670 cfm (30,039 m <sup>3</sup> /hr)
<b>Double Door</b>	-	-	-	-
<b>Weight</b>	59 lbs (27 kg)	84 lbs (38 kg)	76 lbs (35 kg)	88 lbs (40 kg)



GF164SE



GF165/GF165SE



GF210





GX310/GX350



GX400

**GX SERIES**

High performance PPV fans for structural firefighting. The GX Series blowers are equipped with *PowerStream*® air straighteners that tighten the airflow to keep it focused over longer distances without losing significant power; permitting unrestricted setback from the access point, reduced interference with communication and flexible positioning. Optional integrated misters.

	GX310 (18"/46 cm)	GX350 (18"/46 cm)	GX400 (21"/54 cm)		
<b>Order No#</b>	GH5010	GH5005	GE5022	GE5010	GE5003 (CCCF Certified)
<b>Motor</b>	Honda GX160 4.8 Hp (3.5 kW)	Honda GX200 5.5 Hp (4.1 kW)	Honda GX200 5.5 Hp (4.1 kW)	Vanguard 13L333 6.5 Hp (4.8 kW)	Honda GX200 5.5 Hp (4.1 kW)
<b>Run Time</b>	2 hrs 6 min	1 hr 50 min	1 hr 50 min	1 hr 50 min	1 hr 50 min
<b>PPV Airflow</b>					
<b>Single Door</b>	16,968 cfm (28,846 m <sup>3</sup> /hr)	18,705 cfm (31,799 m <sup>3</sup> /hr)	16,797 cfm (28,555 m <sup>3</sup> /hr)	16,797 cfm (28,555 m <sup>3</sup> /hr)	16,797 cfm (28,555 m <sup>3</sup> /hr)
<b>Double Door</b>			22,500 cfm (38,250 m <sup>3</sup> /hr)	22,500 cfm (38,250 m <sup>3</sup> /hr)	22,500 cfm (38,250 m <sup>3</sup> /hr)
<b>Weight</b>	82 lbs (37 kg)	84 lbs (38 kg)	88 lbs (40 kg)	94 lbs (43 kg)	88 lbs (40 kg)

**ACCESSORIES**



**BIGbore™ Exhaust Diverter (Muffler Fitting)**  
 Order# GF7110-CZ (For Honda GC160 Motor)  
 Order# GF7110-KZ (For Honda GXH50 Motor)  
 Order# GF7110-LZ (For Honda GX270 Motor)  
 Order# GF7120-BZ (For Honda GX160 Motor)  
 Order# GF7120-GZ (For Honda GX200 Motor)  
 Order# GF7120-DZ (For Honda GX120 Motor)



**Hour Meter**  
 Keep track regularly  
 schedule maintenance  
 Order# GX1515  
 For use with Honda Motors



**Exhaust Diverter Hose**  
 2" x 12' (5 cm x 3.6 m)  
 Order# GF7115  
 For use with BIGbore™ Exhaust Diverter



**Integrated Misting System**  
 1.85 gal/min@100  
 psi 7 l/min@6.9 bar  
 Order# GH8112 (For GX310, 350)  
 Order# GE8111 (GX400)



**16" (40 cm)  
 Multi-Purpose Accessory Kit**  
 Order# BG16LFA  
 For use with all 16" (40 cm) Fans



**18"/46 cm Duct Adapter/Reducer**  
 Compatible with 18"/46 cm fan  
 and 16"/40 cm duct  
 Order# GH2211  
 For GX310 and GX350



**Cooling Collars/Misters –  
 16" (40 cm) Blowers**  
 Order# ED-MIST16  
 For use with all 16" (40 cm) Fans



**Standard Duct with bags**  
 16"/40 cm x 15'/4.6 m  
 order# FDT-1615BR  
 16"/40 cm x 25'/7.6 m  
 Order# FDT-1625BR  
 For use with all 16" (40 cm) Fans

# «Large Structure Ventilators (LSV)

## Come of age as online commerce grows

Online retailing today is filling warehouses everywhere with products. Adding these to the current inventory of big box stores, airports, high-rises and hotels, the need for tools to fight large structure fires is clear.

These large structures require massive PPV ventilation because you can't support fire fighting operations in a large structure with small structure equipment.

## One huge fan doesn't make sense anymore

Until now, Large Structure Ventilators have been huge monsters that are difficult to move and maneuver, which can limit access to the structure on fire. They require a large storage space and have price tags that are budget-busters. This limits most cities to a single unit for the entire area.

RAMFAN LSV's are the solution to these problems. The largest LSV is a 28" trailer mounted fan that is small enough for one person to maneuver but powerful enough to quickly pressurize a high-rise stairwell and is offered at a price point so low you can buy 6 LSV's for every one truck mounted fan.

## When it comes to equipment access which would you prefer: A single hub or a distributed network?

If your city owns one large truck mounted fan stored in a central location and you respond to a warehouse fire on the outskirts of the city the response time may be too long to get the equipment to the scene. But if you had a distributed network of large fans it would cut the response time in less than half.

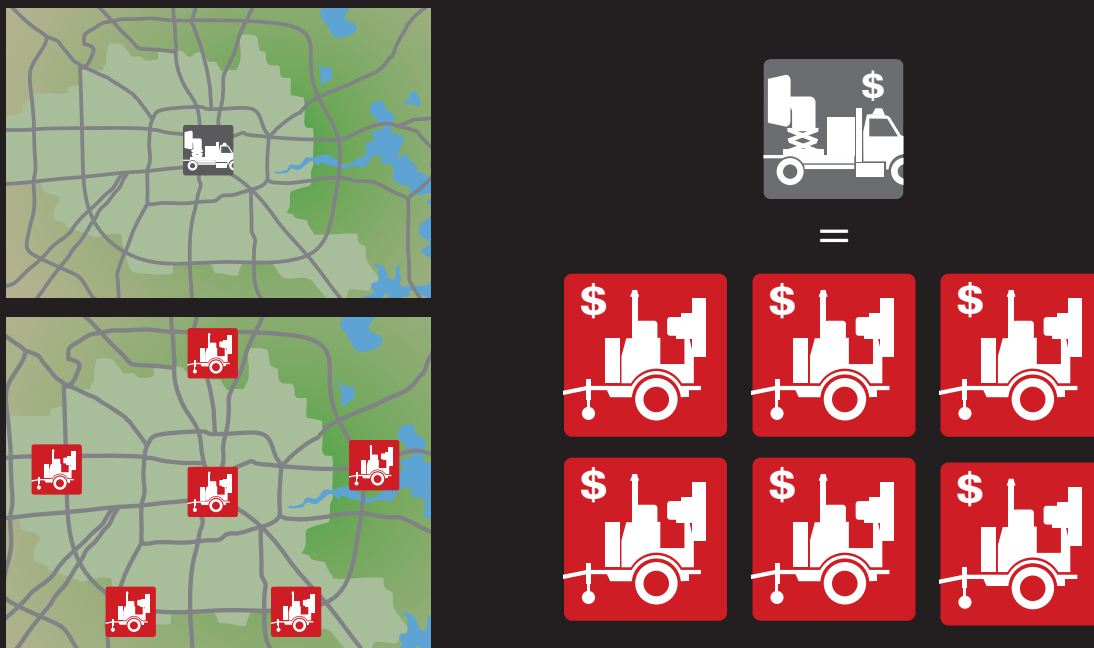

# RAMFAN® GAS LSV Blowers

**LSV = Large Structure Ventilators = Big fans for big buildings**

Large volumes of high-velocity airflow is required for ventilating large and complex structures. Quickly removing smoke, gases, engine exhaust or particulates from a large confined area increases safety of both personnel and property, reducing the chances of toxic inhalation and general atmospheric danger.



## GX SERIES

High performance PPV fans for structural firefighting. The GX Series blowers are equipped with *PowerSteam®* air straighteners that tighten the airflow to keep it focused over longer distances without losing significant power; permitting unrestricted setback from the access point, reduced interference with communication and flexible positioning. Optional integrated misters.

	GX500 (24"/60 cm)	GX600 (28"/70 cm)
<b>Order No#</b>	GD5005, GD5003 (CCCF Certified)	GJ5005
<b>Motor</b>	Honda GX270 8.5 Hp (6.3 kW)	Vanguard 18 Hp (13.4kW) V-Twin OHV mod .35
<b>Run Time</b>	2 hrs 2 min	2 hrs 40 min
<b>PPV Airflow</b>		
<b>Double Door</b>	27,800 cfm (47,260m <sup>3</sup> /hr)	32,500 cfm (55, 250m <sup>3</sup> /hr)
<b>Warehouse Door</b>	37,700 cfm (64,090m <sup>3</sup> /hr)	49,000 cfm (83, 300m <sup>3</sup> /hr)
<b>Weight</b>	137 lbs (62 kg)	175 lbs (80 kg)

	VX700 (Skid Mounted) (28"/70 cm)	VX700 (US Trailer Mounted) (28"/70 cm)	VX700 (European Trailer Mounted) (28"/70 cm)	VX700 (China Trailer Mounted) (28"/70 cm)
<b>Order No#</b>	GK5000	GK5005	GK5010	GK5050
<b>Motor</b>	Honda GX630 23 Hp (17 kW)	Honda GX630 23 Hp (17 kW)	Honda GX630 23 Hp (17 kW)	Honda GX630 23 Hp (17 kW)
<b>Run Time</b>	2 hrs 30 min	2 hrs 30 min	2 hrs 30 min	2 hrs 30 min
<b>PPV Airflow Double Door Warehouse</b>	46,700 cfm (79,390 m <sup>3</sup> /hr), 60,200 cfm (105,400 m <sup>3</sup> /hr)	46,700 cfm (79,390 m <sup>3</sup> /hr), 60,200 cfm (105,400 m <sup>3</sup> /hr)	46,700 cfm (79,390 m <sup>3</sup> /hr), 60,200 cfm (105,400 m <sup>3</sup> /hr)	46,700 cfm (79,390 m <sup>3</sup> /hr), 60,200 cfm (105,400 m <sup>3</sup> /hr)
<b>Weight</b>	220 lbs (100 kg)	920 lbs (417 kg)	920 lbs (417 kg)	920 lbs (417 kg)

## Variations



European Trailer Mounted



Skid Mounted



Continuous Track Mounted



## ACCESSORIES



**BIGbore™ Exhaust Diverter (Muffler Fitting)**  
Order# GF7110-LZ (GX500 and VX700)



**Hour Meter**  
Keep track regularly schedule maintenance  
Order# GX1515 (For use with Honda Motors)



**Exhaust Diverter Hose**  
2" x 12' (5 cm x 3.6 m)  
Order# GF7115

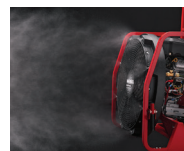

**Integrated Misting System**  
Order# GD8111 (GX500 only)  
Order# GD8111M (GX500 Option BSP)  
Order# GJ8111 (GX600 only)



# « RAMFAN® WATER PPV Blowers

## Safer...

RAMFAN's water powered design eliminates the threat of electrical shock and minimizes dangerous gas environments.

## More Efficient..

RAMFAN's patented Axial Flow Turbine Technology leads the way in converting water power into high velocity airflow more efficiently than any water fan on the market today.

## Better...

RAMFAN's axial turbine is built of corrosion-proof composite materials for long life, simple maintenance and easy replacement of parts.

WF390L (16"/40 cm)	
Order No#	WB5001LB, WB5001LNH, WB5001DIN (CCCF)
PPV Airflow Single Door	10,886 cfm @150 psi (18,506 m <sup>3</sup> /hr @1.0 MPa)
Pressure Nominal:	1.0MPa/150psi
Max:	1.7MPa/250psi
Weight	60 lbs (27 kg)



WF540 (21"/54 cm)	
Order No#	WD5010
Airflow Single Door	22,443 cfm @150 psi (38,154 m <sup>3</sup> /hr@1.0MPa)
Pressure Nominal:	1.0MPa/150psi
Max:	1.7MPa/250psi
Weight	75 lbs (34 kg)

## « ACCESSORIES



### Integrated Misting System

1.85 gal/min @100 psi 7 l/min @ 7 bar

Order# WD8111

(WF540)

Order# WB8111

(WF390L)

Many water connection fittings available. Call for details.



FIRE RESCUE



## Applications

- Equipment Cooling
- Shipboard De-Smoking
- Vessels

# «RAMFAN® WATER Blower/Exhauster & Accessories

No portable blower in the world compares with the smoke removal rates of the WF20 connected to ducting from 10" to 12". Warships at general quarters require powerful suction to remove smoke from interior spaces. The WF20 suctions the smoke from the affected areas through long lengths of ducting to the outside air. At normal fire main pressures of 125 to 150psi, the WF20 makes about 4.5Hp with a 50gpm flow rate.

The WF20 blower uses the water pressure energy of a fire hose and a patented turbine, coupled to a high-efficiency fan blade, to generate high-velocity, high-pressure airflow. The modular construction, choice of corrosion-resistant materials and simplicity assures infrequent and simple maintenance.

Exhaustive testing during U.S. Navy evaluations left the WF20 as the uncontested champion of shipboard de-smoking.



	WF20 (8"/20 cm)			
<b>Order No#</b>	WA5001BSP	WA5001NH	WA5001N	WA5001GL
<b>1.5" Connection Types</b>	BSP Male	NST/NH Male	NPSH Male	BSP Male/AFNOR DN300
<b>Power</b>	4.6 Hp (3.4 kW) @ 150psi (10 bar), 8 Hp (6 kW) @ 250psi (17 bar)			
<b>Free Air Ducted @150psi</b>	10,600 cfm (18,000 m³/hr) 1,835 cfm (3,120 m³/hr)			
<b>Pressure/Flow</b>				
<b>Min:</b>	40psi/29gpm			
<b>Max:</b>	250psi/94gpm			
<b>Weight</b>	35 lbs (15.9 kg)			



## «ACCESSORIES

### RAMFAN WF20

Blower with 1.5" BSP Male (Water)/AFNOR DN300 Type M Duct Couplers  
NATO: 4140-99-051-5733  
Order# WA5001GL

### Kit- US Navy version

blower with 4 duct (DT-1015DVI-3)  
Two 10" Adapters  
Order# 4140-01-333-2224



### Duct

Neoprene Coated  
US Navy Standard (10"x15') (25 cm x 4.6 m)  
US NSN: 4720-01-378-6044  
US NSN: 4140-01-457-9527  
Order# DT-1015DVI-3

### 12" (30 cm) wire reinforced duct

NATO 4130-99-930-5937  
Order# WA0721

### Duct Adapter

10" (25 cm) with Snap-Lock – 2 required/blower  
NSN: 4730-01-378-5288  
Order# WA0411

12" (30 cm) for use with belted duct – 2 required/blower  
Order# WA0511

AFNOR DN 300 Type M (French Norm)  
Order# WA0711

### Multiplier/Mister

NSN:4140-01-414-0670  
Order# WA0802

### Multiplier/Mister with ZAG Adapter

NATO: 4140-01-600-6117  
Order# WA0802-AFNOR

### Strainer Adapter

For use with BIC, Guillemin and storz couplings  
Order# WA2810

### Blower ZAG adapter

Order# ZAGAY

### Multiplier/Mister

ZAG Adapter  
Order# ZAGAY-2



## EURAMCO SAFETY'S CERTIFIED PRODUCT MARK OF EXCELLENCE

Euramco Safety's Certified Product Mark is our visual statement to you that *RAMFAN Portable Ventilation Fans* are Quality Manufactured and have been tested by Recognized Third Party Testing Facilities throughout the world to certify all product performance information quoted in our catalog, sales materials and on our website is accurate. In addition, the Certified Product Mark assures you that all required operating certifications and designations required by the applicable agencies are in order and available for your review.

**Euramco Safety is an ISO 9001:2008 Company:** ISO 9000 is the internationally recognized Quality Management Standard used in more than 760,000 companies in 154 countries to maintain an internationally accepted standardized quality management throughout the world. Our commitment to this standard means our products are built in accordance with documented procedures and control processes to ensure ongoing uniformity and reliability.



**The Air Movement and Control Association** | The *Air Movement and Control Association* is the worldwide recognized authority for the development of standards and measurement of air movement. Euramco Safety is a member of AMCA and uses their PPV test. ANSI/AMCA Standard 240 - *Laboratory Methods of Testing Positive Pressure Ventilators for Aerodynamic Performance Rating* establishes a uniform method of laboratory testing of positive pressure ventilators (PPVs) in order to determine the airflow rate.



**ATEX Hazardous Conditions Directive 94/9/EC** | This directive applies to all electrical equipment for use in potentially explosive atmospheres; defined as gas, vapor or mist and are capable of causing an explosion through their own potential sources of ignition. RAMFAN Hazardous Location Fans are Whole Unit ATEX Certified for use in dangerous work environments as defined above anywhere in the world.



**IECEx** | The objective of the IECEx System is to facilitate international trade for equipment and services for use in explosive atmospheres, while maintaining the required level of safety. The IECEx has put in place a number of Conformity Assessment Schemes which provide assurance that equipment and systems are manufactured and operated according to the highest International Standards of safety.



**Underwriters Laboratories, Inc.** | UL is an independent, third party product safety certification organization that evaluates products for compliance to specific standards and permits those products that comply to carry the UL Mark. The UL Mark is recognized worldwide as a symbol of product safety.



**INMETRO – National Institute of Metrology, Normalization and Industrial Quality in Brazil** | Products obtain the INMETRO Certification Mark when they meet National Standards or specific technical requirements as detailed in the Brazilian Conformity Evaluation System (SBAC).



**Uniform Conformity Procedures Set Forth By the European Union** | The CE Mark is a mandatory marking for certain product groups and certifies that a product meets EU consumer safety, health or environmental requirements. In order to use the CE mark on a product the manufacturer must draw up a Declaration of Conformity in which they attest conformity with all relevant EU Directives.



**China Compulsory Certification of Fire Products** | China Compulsory Certification of fire protection products, also known as "3C certification", it is the Chinese government to protect consumer safety and national security, strengthen product quality management to implement a product conformity assessment system.

















**CSA – Canadian Standard Association** | CSA International is a recognized provider of product testing and certification services throughout the world. The CSA Mark signifies the product has been tested and meets applicable U.S. and Canadian Standards, including those from CSA and UL for safety and performance.



# Certifications & Standards

**PLEASE NOTE:** You can find certification markings from the below organizations throughout the catalog.

CERTIFICATIONS		
LOGO	REPRESENTS	
	ATEX- European Union Hazardous Location Certification by UL International Demko A/S notified by number 0539	
	European Union EMC and Safety	
	Recognized Component Mark for Canada and the United States	
	CSA Mark with other Standards as indicated by the mark below logo.	
	CSA Certified for both Canadian and United States markets	
	CSA Certified to the applicable US Standards for gas and other liquid petroleum products	
	CSA Certified to the applicable Canadian Standards for gas and other liquid petroleum products	
	International Electric Code - worldwide certification standards for electrical equipment used in hazardous locations.	
	INMETRO Mark -Brazilian Hazardous Location Conformity	
	North American Hazardous Location Certification	
	Registered by UL to a specified ISO or QS System.	
RATINGS		
IP RATING	FIRST DIGIT	SECOND DIGIT
IP55	Limited protection against dust ingress. (no harmful deposit)	Protected against low pressure water jets from any direction. Limited ingress permitted.
IP65	Totally protected against dust ingress.	Protected against low pressure water jets from any direction. Limited ingress permitted.
STANDARDS		
ORGANIZATION		
	ANSI American	The American National Standards Institute (ANSI) empowers its members and constituents to strengthen the U.S. marketplace position in the global economy.
	NSN NO.	13-digit numeric code, identifying all the 'standardized material items of supply' as they have been recognized by all NATO countries including United States Department of Defense.
	IMPA CODES	Is used in the marine industry, this aims to bridge the language barrier and offer worldwide shipping companies an easy way to order goods.

# «SERVICES



## Technical Assistance

Our Customer Service Support and Engineers are available to assist you with any set-up, operation or application inquiries during our hours of operation. Operation manuals are also included in product packages. For assistance please contact Customer Service or email [theteam@euramcosafety.com](mailto:theteam@euramcosafety.com).

## Placing Your Order

Contact our Customer Service Department if you need help with placing your order.

For prompt, accurate ordering please be able to provide the following:

- A Purchase Order or letter with the company name or logo, address & approval signature. Purchase Orders must include a P.O. #, Bill To Address, Ship To Address, Model #, Order #, quantity of each products ordered and shipping method.

Purchase Orders can be received by  
**Fax:** +1 (619) 670-7345 or  
**Email:** [theteam@euramcosafety.com](mailto:theteam@euramcosafety.com)

- A confirmation will follow all orders placed.

## Sales and Customer Service

### AMERICA

#### Hours of Operation

M-F 8:30 a.m. – 5:00 p.m. PST

Toll Free 1 (800) 472-6326

Phone +1 (619) 670-9590

Fax +1 (619) 670-7345

### CHINA

#### Hours of Operation

M-F 8:30 a.m. – 5:00 p.m.

Phone +86-574-87979390

Fax +86-574-87979391

### EUROPE – LUXEMBOURG

#### Hours of Operation

M-F 9:00 a.m. – 5:00 p.m.

Phone +352-26008055

Fax +352-26008056

### MIDDLE EAST – DUBAI (Jebel Ali FTZ)

#### Hours of Operation

M-F 4:30 a.m. – 1:00 p.m.

Phone +1 (619) 670-9590 x114

Fax +1 (619) 670-7345

Find us on



<https://www.facebook.com/euramcosafety/>

<https://twitter.com/EuramcoSafety>

<https://www.linkedin.com/company/euramco-safety-worldwide>

<https://www.youtube.com/user/euramcosafety1>

Contents of this catalog are subject to change without notice.

Image Disclaimer: We operate a policy of continuous product development. Images are used for illustration purposes only and may not be the latest version of the product.





**Euramco**

**Go to [www.Euramco.com](http://www.Euramco.com) to find everything you need**

- **Product Information**
- **Online Catalog**
- **Latest Industry News**
- **Certifications**
- **FAQ**
- **Warranty Information**
- **Technical Bulletin**
- **Manuals**

**Distributed by:**

**USA**  
**Euramco Safety**  
 2746 Via Orange Way  
 Spring Valley, CA 91978 USA  
 Toll Free: (800) 472-6326  
 Phone: +1 (619) 670-9590  
 Fax: +1 (619) 670-7345  
[theteam@euramcosafety.com](mailto:theteam@euramcosafety.com)

**LUXEMBOURG**  
**Euramco Safety SARL**  
 68, Avenue de la liberté  
 1931 Luxembourg  
 Luxembourg  
 Phone: +352-26008055  
 Fax: +352-26008056  
[theteam@euramcosafety.com](mailto:theteam@euramcosafety.com)

**MIDDLE EAST – UAE**  
**Euramco Safety Dubai**  
 Jebel Ali FTZ  
 Phone: +1 (619) 670-9590 x114  
 Fax: +1 (619) 670-7345  
[theteam@euramcosafety.com](mailto:theteam@euramcosafety.com)

**CHINA**  
**Euramco Safety China**  
 A11, No. 1 Jinxi Road  
 Qingshuipu, Zhenhai, Zhejiang  
 Ningbo, China 315221  
 Phone: +86-574-87979390  
 Fax: +86-574-87979391  
[saleschina@euramcosafety.com](mailto:saleschina@euramcosafety.com)

©2017 Euramco Safety